

# ANTEA - VERSA

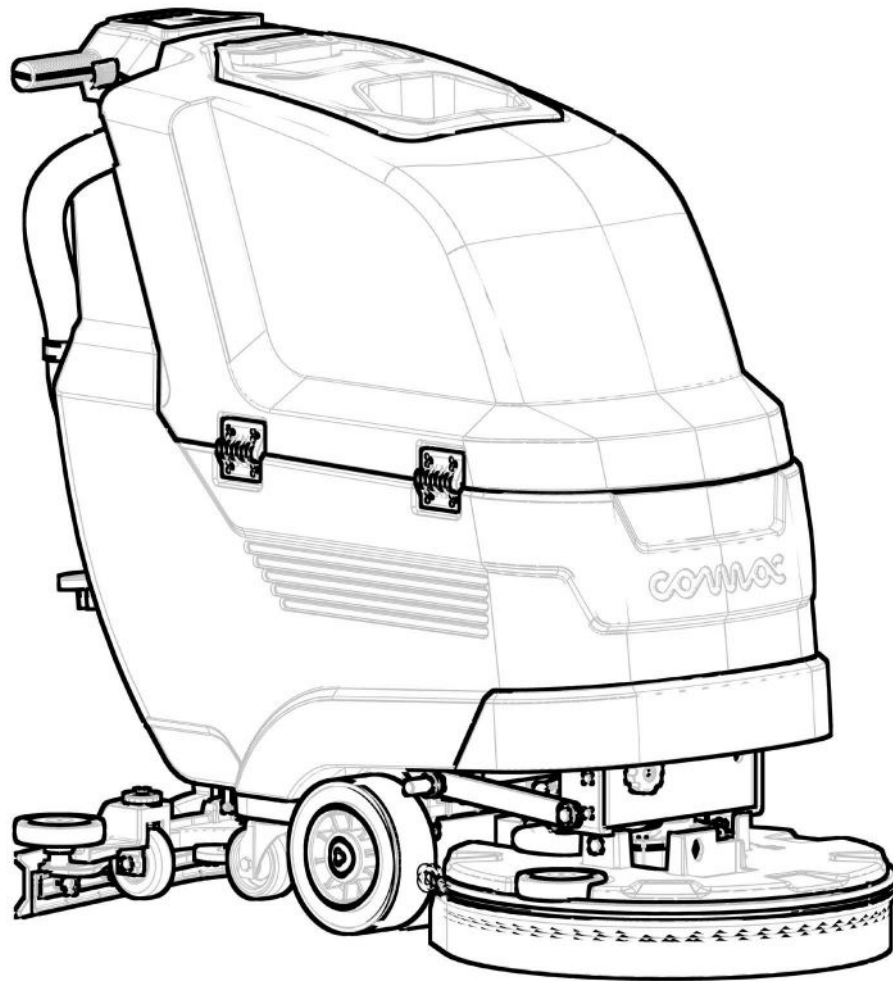

SCRUBBING MACHINES

## USE AND MAINTENANCE MANUAL





## CONTENTS

<b>CONTENTS</b> .....	<b>3</b>	SCRUBBING WITHOUT DRYING (BT - BTS - BTO VERSIONS).....	24
<b>SYMBOLS USED IN THE MANUAL</b> .....	<b>4</b>	DRYING WITHOUT SCRUBBING (BT - BTS - BTO VERSIONS).....	25
<b>PURPOSE AND CONTENT OF THE MANUAL</b> .....	<b>4</b>	ADJUSTING THE DETERGENT SOLUTION (versions without CDS system).....	25
<b>TARGET GROUP</b> .....	<b>4</b>	ADJUSTING THE DETERGENT SOLUTION (versions with CDS system).....	25
<b>STORING THE USE AND MAINTENANCE MANUAL</b> .....	<b>4</b>	FORWARD SPEED REGULATION (B versions).....	26
<b>ON DELIVERY OF THE APPLIANCE</b> .....	<b>4</b>	ADJUSTING THE FORWARD MOVEMENT SPEED (BT - BTS - BTO VERSIONS).....	26
<b>INTRODUCTORY COMMENT</b> .....	<b>4</b>	REVERSE MOVEMENT (BT - BTS - BTO VERSIONS).....	26
<b>IDENTIFICATION DATA</b> .....	<b>4</b>	EMERGENCY SWITCH (BT - BTS - BTO VERSIONS).....	26
<b>TECHNICAL DESCRIPTION</b> .....	<b>4</b>	ECO-MODE FUNCTION (versions BT - BTS - BTO).....	26
<b>INTENDED USE</b> .....	<b>4</b>	ALARM SCREEN (BT - BTS - BTO versions).....	26
<b>SAFETY</b> .....	<b>4</b>	OVERFLOW DEVICE (B versions).....	27
<b>REGISTRATION PLATE</b> .....	<b>4</b>	VACUUM WAND KIT (versions with SST system).....	27
<b>SPECIAL EQUIPMENT</b> .....	<b>4</b>	OVERFLOW DEVICE.....	27
<b>TECHNICAL DATA</b> .....	<b>5</b>	<b>AT THE END OF THE WORK</b> .....	<b>27</b>
<b>TECHNICAL DATA (VERSA)</b> .....	<b>6</b>	<b>MAINTENANCE</b> .....	<b>28</b>
<b>GENERAL SAFETY REGULATIONS</b> .....	<b>7</b>	RECOMMENDED MAINTENANCE OPERATIONS.....	28
RECHARGING THE BATTERIES.....	7	EMPTYING THE RECOVERY TANK.....	28
USING THE APPLIANCE.....	8	EMPTYING THE DEBRIS HOPPER (50BTS double brush versions).....	28
DEACTIVATION OF THE MACHINE.....	10	EMPTYING THE DEBRIS HOPPER (65 BTS double brush versions).....	29
MAINTENANCE.....	10	CLEANING THE SQUEEGEE BODY.....	29
TRANSPORT.....	11	CLEANING THE RECOVERY TANK FILTER-FLOAT.....	30
<b>SYMBOLS USED ON THE APPLIANCE</b> .....	<b>13</b>	CLEANING THE BRUSH (B single brush version).....	31
SYMBOLS PRESENT ON THE REGISTRATION PLATE.....	13	CLEANING THE BRUSH (BT single brush version).....	31
SYMBOLS PRINTED ON THE APPLIANCE.....	13	CLEANING THE BRUSH (BT single brush version with PM system).....	31
LABELS PRESENT ON THE APPLIANCE.....	13	CLEANING THE BRUSH (BT double brush versions).....	31
SYMBOLS USED ON THE INSTRUMENT PANEL (version B).....	13	CLEANING THE BRUSH (BT double brush versions with PM system).....	31
SYMBOLS USED ON THE INSTRUMENT PANEL (versions BT - BTS - BTO).....	13	CLEANING THE BRUSH (50BTS double brush versions).....	32
<b>DISPLAY SCREENS (versions BT - BTS - BTO)</b> .....	<b>14</b>	CLEANING THE BRUSH (65BTS double brush versions).....	32
<b>PREPARING THE APPLIANCE</b> .....	<b>15</b>	CLEANING THE DEBRIS HOPPER (50BTS double brush versions).....	33
HANDLING THE PACKED APPLIANCE.....	15	CLEANING THE DEBRIS HOPPER (65BTS double brush versions).....	33
HOW TO UNPACK THE APPLIANCE (versions without PM).....	15	CLEANING THE VACUUM TUBE.....	33
HOW TO UNPACK THE APPLIANCE (versions with PM).....	15	EMPTYING THE SOLUTION TANK.....	34
HOW TO TRANSPORT THE APPLIANCE.....	16	CLEANING THE WATER SYSTEM FILTER.....	34
COMPONENT POSITIONING.....	16	CLEANING THE WATER SYSTEM (B versions).....	34
APPLIANCE SAFETY.....	17	CLEANING THE WATER SYSTEM (versions BT - BTS - BTO).....	35
TYPE OF BATTERY TO BE USED.....	17	CLEANING THE WATER SYSTEM (versions BT - BTS - BTO with PM system).....	35
BATTERY MAINTENANCE AND DISPOSAL.....	17	CLEANING THE WATER SYSTEM (versions BT - BTS - BTO with CDS system).....	36
INSERTING BATTERIES INTO THE DEVICE.....	17	CLEANING THE WATER SYSTEM (versions BT - BTS - BTO with PM and CDS system).....	37
CONNECTING BATTERIES TO THE SYSTEM OF THE APPLIANCE.....	18	CLEANING THE RECOVERY TANK.....	38
RECHARGING THE BATTERIES.....	18	CLEANING THE SOLUTION TANK.....	39
RECHARGING THE BATTERIES (versions with CB system).....	18	CLEANING THE DETERGENT CANISTER (versions with CDS system).....	39
HOUR METER (B versions).....	19	<b>ADJUSTING</b> .....	<b>39</b>
HOUR METER (BT versions).....	19	ADJUSTING THE SQUEEGEE UNIT.....	39
BATTERY CHARGE LEVEL INDICATOR (B versions).....	19	<b>EXTRAORDINARY MAINTENANCE</b> .....	<b>40</b>
BATTERY CHARGE LEVEL INDICATOR (BT versions).....	19	REPLACING THE SQUEEGEE BODY RUBBER BLADES.....	40
INSTALLING THE BRUSH (B - BT single brush versions).....	19	<b>DISPOSAL</b> .....	<b>40</b>
INSTALLING THE BRUSH HEAD BRUSH (B - BT single brush versions).....	19	<b>EC DECLARATION OF CONFORMITY</b> .....	<b>40</b>
INSTALLING THE BRUSH (BT double brush versions).....	20	<b>TROUBLESHOOTING</b> .....	<b>41</b>
INSTALLING THE BRUSH HEAD BRUSH (BT double brush versions).....	20	<b>CHOOSING AND USING BRUSHES</b> .....	<b>42</b>
INSTALLING THE BRUSH (50BTS double brush versions).....	20		
INSTALLING THE BRUSH (65BTS double brush versions).....	20		
INSTALLING THE ABRASIVE PAD (BTO versions).....	20		
ASSEMBLING THE SQUEEGEE BODY.....	21		
FILLING THE SOLUTION TANK WITH WATER.....	21		
ADJUSTING THE DETERGENT SOLUTION (versions without CDS system).....	21		
FILLING THE DETERGENT CANISTER (versions with CDS system).....	21		
<b>PREPARING TO WORK</b> .....	<b>22</b>		
<b>WORK</b> .....	<b>23</b>		
STARTING WORK (B versions).....	23		
SCRUBBING AND DRYING (B versions).....	23		
SCRUBBING WITHOUT DRYING (B versions).....	23		
DRYING (B versions).....	23		
STARTING THE WORK ACTIVITIES (BT - BTS - BTO VERSIONS).....	24		
SCRUBBING AND DRYING (BT - BTS - BTO VERSIONS).....	24		

The descriptions contained in this document are not binding. The company therefore reserves the right to make any modifications at any time to elements, details, or accessory supply, as considered necessary for reasons of improvement or manufacturing/commercial requirements. The reproduction, even partial, of the text and drawings contained in this document is prohibited by law.

The company reserves the right to make any technical and/or supply modifications. The images are shown as reference only and are not binding as to the actual design and/or equipment.

## SYMBOLS USED IN THE MANUAL

	<b>Open book symbol with an "i":</b> Indicates the need to consult the instruction manual.
	<b>Open book symbol:</b> Tells the operator to read the user manual before using the device.
	<b>Covered place symbol:</b> The operations preceded by this symbol must always be carried out in a dry, covered area.
	<b>Information symbol:</b> Indicates additional information for the operator, to improve the use of the device.
	<b>Warning symbol:</b> Carefully read the sections preceded by this symbol meticulously following the instructions indicated for the safety of the operator and the device.
	<b>Danger symbol (corrosive substances):</b> The operator should always wear protective gloves to avoid the risk of serious injury to the hands caused by corrosive substances.
	<b>Danger symbol (battery acid leakage):</b> Indicates the danger of leaking acid or acid fumes from the batteries while they are being recharged.
	<b>Danger symbol (moving carriages):</b> Indicates that the packed product should be handled with suitable carriages that conform to legal requirements.
	<b>Mandatory room ventilation symbol:</b> Informs the operator that the room must be ventilated while the batteries are being recharged.
	<b>Symbol indicating the compulsory use of protective gloves:</b> Indicates that the operator should always wear protective gloves, to avoid the risk of serious injury to his hands from sharp objects.
	<b>Symbol indicating a treading ban:</b> Informs the operator that it is forbidden to tread on machine components, as this could lead to serious injury.
	<b>Recycling symbol:</b> Tells the operator to carry out the operations in compliance with environmental regulations in force in the place where the appliance is being used.
	<b>Disposal symbol:</b> Carefully read the sections marked with this symbol for disposing of the appliance.

## PURPOSE AND CONTENT OF THE MANUAL

The aim of this manual is to provide customers with all the information needed to use the appliance in the safest, most appropriate and most autonomous way. It includes information concerning technical aspects, safety, operation, appliance downtime, maintenance, spare parts and scrapping. Operators and qualified technicians must read the instructions in this manual carefully before carrying out any operation on the appliance. If in doubt about the correct interpretation of instructions, contact your nearest Customer Service Centre to obtain the necessary clarifications.

## TARGET GROUP

This manual is aimed at operators and qualified technicians responsible for appliance maintenance. Operators must not perform operations that should be carried out by qualified technicians. The manufacturer is not liable for damages resulting from failure to comply with this veto.

## STORING THE USE AND MAINTENANCE MANUAL

The Use and Maintenance Manual must be stored in its special pouch close to the appliance, protected from liquids and anything else that could compromise its legibility.

## ON DELIVERY OF THE APPLIANCE

When the machine is delivered to the customer, an immediate check must be performed to ensure all the material mentioned in the shipping documents has been received, in addition to verifying that the equipment has not been damaged during transportation. If this is the case, the carrier must ascertain the extent of the damage at once, informing our customer service office. It is only by prompt action of this type that the missing material can be obtained, and compensation for damage successfully claimed.

## INTRODUCTORY COMMENT

Any type of equipment can only work properly and effectively if used correctly and kept in full working order by performing the maintenance operations described in the attached documentation. You should therefore read this instruction manual carefully, consulting it again if issues arise while using the machine. If necessary, remember that our assistance service (organised in collaboration with our dealers) is always available for advice or direct intervention.

## IDENTIFICATION DATA

For technical assistance or to request replacement parts, always give the model, the version and the serial number (written on the relevant plate).

## TECHNICAL DESCRIPTION

The **ANTEA** and the **VERSA** are scrubbing machines that, using the mechanical action of one or more brushes and the chemical action of a water-detergent solution, can clean a wide range of floors and types of dirt, collecting, when it is moving forward, the dirt removed and the detergent solution not absorbed by the floor.

The appliance must only be used for this purpose.

## INTENDED USE

These scrubbing machines were designed and built for cleaning (scrubbing and drying) smooth, compact flooring in the commercial, residential and industrial sectors by a qualified operator in proven safety conditions.

The scrubbing machine is not suitable for cleaning rugs or carpet floors.

The appliance is only suitable for use in indoor - or at least covered - areas.

**N.B.:** the appliance is not suitable for use in the rain, or under jets of water.

**IT IS FORBIDDEN** to use the appliance for picking up dangerous dusts or inflammable liquids in places with an explosive atmosphere. In addition, it is not suitable as a means of transport for people or objects.

## SAFETY

Operator cooperation is paramount for accident prevention. No accident prevention programme can be effective without the full co-operation of the operator who is directly responsible for machine operation. The majority of occupational accidents that happen both in the workplace or whilst moving are caused by failure to respect the most basic safety rules. An attentive, careful operator is most effective guarantee against accidents and is fundamental in order to implement any prevention programme.

## REGISTRATION PLATE

The registration plate is located on the lower portion of the recovery tank, inside the appliance, and contains the following information:

1. The weight of the batteries used to power the appliance (expressed in Kg).
2. The gross weight of the appliance (expressed in Kg).
3. The IP protection rating of the appliance.
4. The identification code of the appliance.
5. The serial number of the appliance.
6. The name of the appliance.
7. The nominal power consumed by the appliance (expressed in W).
8. The maximum grade that the appliance can handle during work activities (expressed in %).
9. The year in which the appliance was manufactured.
10. The nominal voltage of the appliance (expressed in V).
11. The commercial name of the appliance and the manufacturer's address.

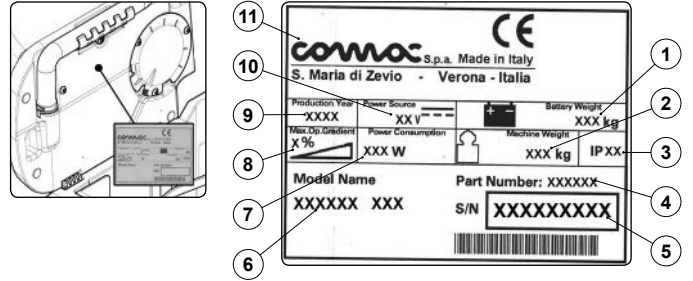

## SPECIAL EQUIPMENT

Each design is based on the objective or giving the client a new reason for choosing Comac spa products, the Antea and Versa can be fitted with the following devices:

- **ECO-MODE:** a device that decreases the noise level and lowers energy consumption. The paragraphs in the document that talk about the following equipment will have the wording "ECO-MODE".
- **COMAC DOSING SYSTEM:** this is the dosing system for the separate management of water and detergent, and allows you to increase or reduce the delivery depending on the dirt to be treated. The paragraphs in the document that talk about the following equipment will have the wording "CDS".
- **PRESSURE MONITORING:** a system that monitors the power dispensed by the brush motors in order to guarantee maximum effectiveness on any type of floor. The paragraphs in the document that talk about the following equipment will have the wording "PM".
- **ON-BOARD BATTERY CHARGER:** a system that makes it much easier to charge the batteries, because the charging device is already present in the appliance itself. The paragraphs in the document that talk about the following equipment will have the wording "CB".
- **SPRAY AND SUCTION TOOLS:** a system that allows you to spray detergent solution where the appliance cannot reach, moreover, thanks to the vacuum accessory it is possible to collect everything leaving the floor dry. The paragraphs in the document that talk about the following equipment will have the wording "SST".





TECHNICAL DATA	U/M	ANTEA 50 B	ANTEA 50 BT	ANTEA 50 BTS	ANTEA 50 BTO Orbital
Rated power of the device	W	920	1100	1200	1000
Working width	mm	508	508	500	508
Working capacity up to	m <sup>2</sup> /h	1250	1780	1750	1780
Maximum gradient with full load	%	2	10	10	10
Standard squeegee width	mm	700	700	700	700
Disc brush (number / diameter)	No. / Ø mm	1 / 508	1 / 508	-	-
Disc brush rotations	rpm	140	140	-	-
Brush head motor (Nominal power rating / Voltage)	W / V	500 / 24	500 / 24	600 / 24	400 / 24
Cylindrical brush (number / (diameter - length))	No. / (Ø mm - mm)	-	-	2 / (110 - 500)	-
Cylindrical brush rotations	rpm	-	-	700	-
Rectangular pad (number / (width / depth))	No. / (mm - mm)	-	-	-	1 / (508 / 355)
Discoid pad (number / (diameter))	No. / Ø mm	-	-	-	-
Orbital revolutions	rpm	-	-	-	2300
Maximum weight exerted upon the brush head unit	kg	23	23	25	25
Front wheel [number / (diameter / width)]	no. / (Ø mm / mm)	2 / (175-60)	2 / (175-60)	2 / (175-60)	2 / (175-60)
Traction motor (Nominal power rating / Voltage)	W / V	-	180	180	180
Maximum forward speed	Km/h	-	3.5	3.5	3.5
Maximum reverse speed	Km/h	-	2.2	2.2	2.2
Vacuum motor (Nominal power rating / Voltage)	W / V	420 / 24	420 / 24	420 / 24	420 / 24
Vacuum power (hole Ø 0 measured at the motor)	mmH <sub>2</sub> O	1240	1240	1240	1240
Solution tank capacity	l	40	40	40	40
Recovery tank capacity	l	60	60	60	60
Detergent tank capacity (versions with CDS)	l	-	3	3	3
Appliance length	mm	1177	1177	1156	1071
Appliance height	mm	992	1009	1009	1009
Appliance width (without squeegee)	mm	591	591	612	591
Device width (with squeegee)	mm	700	700	700	700
Battery compartment dimensions (Height - Width - Length)	mm	285 - 350 - 355	285 - 350 - 355	285 - 350 - 355	285 - 350 - 355
Voltage and nominal capacity of the recommended battery	V/Ah	12 / 105	12 / 105	12 / 105	12 / 105
Device weight (with tanks empty and without batteries)	kg	80	87	90	89
Individual battery weight	kg	38	38	38	38
Device transport weight (device + batteries)	kg	156	163	166	165
Gross weight of the device ready for use	kg	196	203	206	205
Sound pressure level (ISO 11201) - L <sub>PA</sub>	dB (A)	<70	<70	<70	71
Uncertainty K <sub>PA</sub>	dB (A)	1.5	1.5	1.5	3
Hand vibration level (ISO 5349)	m/s <sup>2</sup>	< 2.5	< 2.5	< 2.5	< 2.5
Vibration measurement uncertainty		1.5%	1.5%	1.5%	1.5%

TECHNICAL DATA (VERSA)	U/M	VERSA 55 BT	VERSA 65 BT	VERSA 65 BTS
Rated power of the device	W	1415	1415	1580
Working width	mm	560	655	650
Working capacity up to	m <sup>2</sup> /h	1960	2295	2275
Maximum gradient with full load	%	10	10	10
Standard squeegee width	mm	800	800	800
Disc brush (number / diameter)	No. / Ø mm	2 / 290	2 / 340	-
Disc brush rotations	rpm	240	240	-
Brush head motor (Nominal power rating / Voltage)	W / V	400 / 24	400 / 24	400 / 24
Cylindrical brush (number / (diameter - length))	No. / (Ø mm - mm)	-	-	2 / (Ø130 - 610)
Cylindrical brush rotations	rpm	-	-	590
Maximum weight exerted upon the brush head unit	kg	25	30	30
Front wheel [number / (diameter / width)]	no. / (Ø mm / mm)	2 / (175-60)	2 / (175-60)	2 / (175-60)
Traction motor (Nominal power rating / Voltage)	W / V	180	180	180
Maximum forward speed	Km/h	3.5	3.5	3.5
Maximum reverse speed	Km/h	2.2	2.2	2.2
Vacuum motor (Nominal power rating / Voltage)	W / V	420 / 24	420 / 24	420 / 24
Vacuum power (hole Ø 0 measured at the motor)	mmH <sub>2</sub> O	1240	1240	1240
Solution tank capacity	l	62	62	62
Recovery tank capacity	l	66	66	66
Detergent tank capacity (versions with CDS)	l	3	3	3
Debris hopper volume (BTS versions)	dm <sup>3</sup>	-	-	3.9
Appliance length	mm	1190	1196	1160
Appliance height	mm	1050	1050	1050
Appliance width (without squeegee)	mm	620	695	735
Device width (with squeegee)	mm	800	800	800
Device wheel track	mm	465	465	465
Device pitch	mm	270	270	270
Battery compartment dimensions (Height - Width - Length)	mm	285 - 350 - 355	285 - 350 - 355	285 - 350 - 355
Voltage and nominal capacity of the recommended battery	V/Ah	12 / 112	12 / 112	12 / 112
Device weight (with tanks empty and without batteries)	kg	92	95	95
Individual battery weight	kg	38	38	38
Device transport weight (device + batteries)	kg	168	171	171
Gross weight of the device ready for use	kg	237	240	240
Sound pressure level (ISO 11201) - L <sub>pA</sub>	dB (A)	<70	<70	<70
Uncertainty K <sub>pA</sub>	dB (A)	1.5	1.5	1.5
Hand vibration level (ISO 5349)	m/s <sup>2</sup>	< 2.5	< 2.5	< 2.5
Vibration measurement uncertainty		1.5%	1.5%	1.5%



## GENERAL SAFETY REGULATIONS

The following symbols are used to indicate any potentially hazardous situations. Always read this information carefully and take the necessary precautions to protect any people and/or objects that may be present.

Operator cooperation is paramount for accident prevention. No accident prevention programme can be effective without the full co-operation of the operator who is directly responsible for the operation of the appliance. Most accidents that occur at the workplace, during work activities, or while in transit, are caused by the failure to respect the most basic safety regulations. An attentive, careful operator is most effective guarantee against accidents and is fundamental in order to implement any prevention programme.

-  **DANGER:** Indicates an imminent danger that could cause serious injury or death.
-  **WARNING:** Indicates a probable dangerous situation that could cause serious injury or death.
-  **CAUTION:** Indicates a probable dangerous situation that could cause minor injuries.
-  **ATTENTION:** Indicates a probable dangerous situation that could damage objects.

## RECHARGING THE BATTERIES

-  **DANGER:**
  - If the battery charger power cable is damaged or broken, it should be replaced by the manufacturer or authorised service personnel, or another qualified person, in order to protect against hazards.
  - The socket for the battery charger cable must have a prescribed earth connection.
  - Keep sparks, flames, and incandescent materials at a safe distance from the batteries. Explosive gases are emitted during normal use.
  - highly explosive hydrogen gas is generated while charging the batteries. Keep the recovery tank in a maintenance position during the entire battery recharging cycle, and only perform the procedure in well-ventilated areas at a safe distance from any open flames.
  - Before charging, make sure the electric cable that connects the battery charger to the batteries is not damaged. If it is, don't use it; contact technical assistance.
  - Before charging, make sure the electric cable that connects the battery charger to the mains is not damaged. If it is, don't use it; contact technical assistance.
  - Do not disconnect the DC cable of the battery charger from the socket on the appliance while the battery charger is operating. This is necessary in order to avoid electric arcs forming. To disconnect the battery charger when it is charging, first disconnect the alternating current power cable.
-  **WARNING:**
  - Do not use an incompatible battery charger as it could damage the batteries and potentially cause a fire.
  - The batteries emit hydrogen gas. This gas can cause explosions or fires. Stay away from any flames and sparks. keep the covers open when charging the batteries.
  - Before using the battery charger, make sure that the frequency and the voltage values indicated on the machine's data plate coincide with the network's values.

- Keep the battery charger's cable at a safe distance from any hot surfaces.
- Never smoke near the machine while the batteries are charging.
- Before starting the charging operation, carefully read the user manual of the battery charger that you want to use.

## USING THE APPLIANCE



### DANGER:

- In the event of danger, quickly disconnect the battery connector from the electrical system connector, both are located inside the appliance under the recovery tank (B versions).
- In the event of danger, quickly press the emergency button on the back of the device (valid for BT-BTS-BTO versions).
- Never collect gases, explosive/inflammable liquids or powders, nor acids and solvents! These include gasoline, paint thinners and fuel oil (which, when mixed with the vacuum air, can form explosive vapours or mixtures), and also non-diluted acids and solvents, acetones, aluminium and magnesium powders. These substances may also corrode the materials used to construct the appliance.
- Do not use the machine where there are inflammable liquids, vapours or combustible powders. The machine does not have an explosion-proof motor. The electric motors generate sparks both when starting and when being used, therefore they could cause fires or explosions if used in areas where there are inflammable liquids, vapours or combustible powders.
- If the appliance is used in dangerous areas (for example, gas stations), the relative safety standards should be observed. The appliance must never be used in environments with a potentially explosive atmosphere.



### WARNING:

- The appliance must be only used by authorised, trained personnel.
- Do not use the appliance on surfaces with an inclination greater than the one shown on the registration plate.
- The appliance is not suitable for cleaning rough or uneven floors. Do not use the appliance on slopes.
- In the event of a fire, use a powder extinguisher. Do not use water.
- Adapt the speed to the adhesion conditions.
- In order to prevent any unauthorised use of the appliance, the power supply should be interrupted, turning off the appliance using the main switch (and then removing the key from the cylinder versions with traction drive) and disconnecting the battery connector from the electrical system connector.
- Do not use the appliance if you do not have the required knowledge or authorisation.
- Do not use the appliance if you have not read and understood the following user manual.
- Do not use the appliance under the influence of alcohol or drugs.
- Do not use the appliance while using a mobile phone or other electronic devices.
- Do not use the appliance if it is not working correctly.
- Do not use the appliance in areas where there are inflammable liquids or vapours or combustible powders.
- Do not use the appliance in areas that are too dark to see the controls or to use the machine safely.
- Do not use the appliance in areas where there is a risk of falling objects.



 **CAUTION:**

- **The appliance should not be used by people (including children) with reduced physical, sensory or mental capabilities or who do not have the necessary experience or knowledge of the appliance.**
- Children must be supervised to ensure they do not play with the machine.
- When using the appliance, pay attention to other people and especially to children.
- The appliance must only be powered with the voltage shown on the registration plate.
- Carefully read the labels on the appliance. Do not cover them for any reason and replace them immediately if they become damaged.
- The appliance must always be stored and used in an enclosed space or under cover.
- The appliance must not be used or kept outdoors in damp conditions or directly exposed to rain.
- The appliance does not cause harmful vibrations.
- Use the appliance only in the manner described in this manual.
- Do not collect inflammable or steaming refuse, like cigarettes, matches and hot embers.
- Reduce speed along dangerous bends or slopes.
- Reduce speed before turning.
- Pay attention when reversing.
- Always follow the instructions on the containers for mixing, using and disposing of chemical substances.

 **ATTENTION:**

- The appliance is intended for commercial use, like for example schools, hotels, hospitals, factories, shops and offices.
- When using the appliance, be careful not to injure people or damage objects.
- Be careful to avoid collisions with shelving or scaffolding, above all if there is a risk of objects falling from heights.
- Do not place any liquid containers on the appliance.
- The operating temperature of the appliance should be between 0 °C and +40 °C.
- When using detergents to clean the flooring, always follow the instructions and respect the warnings indicated on the containers' labels.
- Always use appropriate gloves and protective equipment when handling the detergents used to clean the floor.
- Do not use the appliance as a means of transport.
- Avoid using the brushes while the appliance is standing still, so as not to damage the floor.
- In the event of a fire, use a powder fire extinguisher if possible, and avoid the use of water.
- Do not allow any objects to penetrate into the machine's openings. Do not use the appliance if the openings are obstructed.
- Keep the appliance's openings free of any dust, lint, hairs, or any other foreign materials that could reduce the airflow.
- Do not remove or alter any labels affixed to the appliance.
- This appliance has not been approved for use on public streets or roadways.
- Use only brushes and pad holders supplied with the appliance or those specified in the following manual. The use of other brushes or felt pads could compromise the machine's safety conditions.
- Before starting to work, check there are no leaks.
- Before starting to work, check that all the safety devices have been installed and are working correctly.

## DEACTIVATION OF THE MACHINE

### **WARNING:**

- Always protect the appliance from the sun, rain and other bad weather, when it is operating and when it is not. Store the appliance in a covered, dry place: this appliance is only for dry use and should never be used or kept outdoors in damp conditions.
- Do not park the appliance near combustible materials, powders, gases or liquids.
- Stop the appliance on a flat surface.
- To prevent unauthorised use of the appliance, the power supply should be disconnected. Switch off the appliance using the main switch and disconnect the battery connector from the electrical system connector.
- In order to prevent any unauthorised use of the appliance, the power supply should be deactivated by turning off the main switch (and then removing the key from the ignition) and disconnecting the battery connector from the electrical system connector (valid for BT - BTS - BTO versions).
- When left unattended, the appliance must be protected against unintentional movements

### **ATTENTION:**

- The appliance must be stored at a temperature between 0 °C and +40 °C. The humidity level must be between 30% and 95%.

## MAINTENANCE

### **DANGER:**

- In order to avoid short-circuits when working in the vicinity of electrical components, do the following: avoid the use of non-insulated tools; do not place or allow metallic objects to fall upon the electrically powered components; remove any rings, watches and/or clothing with metallic parts that might come into contact with the electrically powered components.
- Do not spray or wet the machine to avoid the risk of electrical faults. Use a damp cloth.

### **WARNING:**

- Read all the relevant instructions carefully before performing any maintenance/repair operations.
- If the machine does not work properly, check this is not caused by failure to carry out routine maintenance. Otherwise, ask for intervention of the authorised technical assistance centre.
- Restore all electrical connections after any maintenance interventions.

### **CAUTION:**

- **When doing maintenance work, switch off the machine using the main switch. Remove the key from the instrument panel and remove the battery connector from the electrical system connector. Also, make sure the battery charger power cable is disconnected from the appliance and the mains socket.**
- Avoid contact with moving parts. Do not wear loose clothing or jewellery and tie up long hair.
- Block the wheels before lifting the machine.
- Lift the machine with equipment suitable for the weight to be lifted.

 **ATTENTION:**

- **The cleaning and maintenance of the appliance should not be carried out by people (including children) who do not have the necessary experience with and knowledge of the appliance.**
- Never tamper with the machine's protection devices for any reason; always follow the supplied routine maintenance instructions scrupulously.
- If the machine needs to be pushed for maintenance purposes (batteries absent; discharged batteries; etc.), never exceed 4 km/h.
- If any issues are encountered while using the machine, check to make sure that these are not due to a lack of proper maintenance. Otherwise, request the intervention of authorized personnel or an Authorized service centre.
- If any parts need to be replaced, always request ORIGINAL spare parts from an authorized Dealer or Retailer.
- In order to ensure the machine's safety and proper functionality, always have the scheduled maintenance interventions (specified in the appropriate section of this Manual) performed by authorized personnel or by an authorized Service Centre.
- Do not clean the machine with direct or pressurized jets of water, or with corrosive substances.
- If lead batteries (WET) have been installed on the machine, avoid tilting the machine beyond 30° with respect to the horizontal plane, as this could cause the highly corrosive liquid to leak out of the batteries.
- Avoid contact with the battery acid.
- Keep all metal objects away from the batteries.
- Use a non-conductive device for removing the battery.
- Use a hoist and suitable equipment when lifting the batteries.
- The battery must be installed by qualified personnel.
- Always observe the safety measures of the site regarding battery removal.
- Remove the batteries if the machine needs to be tilted in order to perform maintenance procedures.
- Have the machine checked by an authorised technical assistance centre every year.
- When disposing of consumable materials, observe the laws and regulations in force. Once the machine has reached the end of its service life, the materials contained within it must be disposed of in an appropriate manner, keeping in mind that the machine itself has been built using fully recyclable materials.
- Only push or tow the machine when the seat is occupied by an operator able to control the machine.
- Do not wash the machine with pressurised water or wet the machine near electrical components.
- All repairs must be carried out by qualified personnel.
- Do not physically change the design characteristics of the machine.
- Use spare parts supplied by Comac or by Comac service centres.
- Wear personal protective equipment as required and as suggested in the manual.

## TRANSPORT

 **WARNING:**

- Empty both tanks before transporting.
- Put the squeegee and the brushes in their work position before securing the machine to the transport vehicle.
- Use a ramp, a truck or trailer capable of supporting the weight of the machine and the operator.

- Use a winch to put the machine on the transport vehicle. Do not drive the machine onto a truck or a trailer.
- In order to put the machine on the transport vehicle, the ramp should not have such an inclination that the machine gets damaged.
- Engage the parking brake after loading the machine onto the transport vehicle.



**ATTENTION:**

- The machine must only be stored under temperature conditions ranging from 0 °C to +40 °C. The humidity level must be between 30% and 95%.

## SYMBOLS USED ON THE APPLIANCE

### SYMBOLS PRESENT ON THE REGISTRATION PLATE

	<b>Direct current symbol:</b> Used on the appliance's registration plate to indicate that the appliance is powered by a DC power supply.
	<b>Battery symbol:</b> Used on the appliance's registration plates to indicate the mass of the batteries used to power the appliance (expressed in Kg). The value refers to the batteries recommended by the manufacturer (read paragraph titled " <a href="#">TYPE OF BATTERY TO BE USED</a> ").
	<b>Maximum gradient symbol:</b> Used on the registration plate of the device, to indicate the maximum gradient that can be safely handled by the device in work mode.

### SYMBOLS PRINTED ON THE APPLIANCE

	<b>Tank empty symbol:</b> Used on the rear of the device to indicate the position of the solution tank drainage cap.
	<b>Brush head unit control symbol:</b> Used on the rear of the appliance, to indicate the position of the brush head control pedal.
	<b>Tap position symbol:</b> Used on the rear of the appliance, to indicate the position of the detergent solution control tap.
	<b>Cap/filter position symbol:</b> Used on the rear of the device to indicate the position of the solution tank cap/filter.
	<b>Symbol of maximum temperature for filling the solution tank:</b> Used on the side of the device, to indicate the maximum temperature of the water for filling the solution tank safely.

### LABELS PRESENT ON THE APPLIANCE

	<b>Squeegee in "WORK" position symbol:</b> This is used in the rear of the machine to indicate where the squeegee control lever needs to be positioned for work mode.
	<b>Squeegee in "RESTING" position symbol:</b> This is used in the rear of the machine to indicate where the squeegee control lever needs to be positioned for idle mode.
	<b>Detergent flow control symbol.</b> Used on the rear of the device to indicate the position of the detergent solution flow adjustment lever.
	<b>Symbol for work speed regulation (B versions):</b> Used on the brush head unit to indicate the knob for adjusting the working speed of the device in the version without traction.
	<b>Squeegee unit vacuum hose position:</b> Used on the back of the appliance to identify the correct position for the squeegee unit's vacuum hose. The tube must be positioned behind the squeegee unit's lifting chain.
	<b>Warning label:</b> Affixed to the appliance in order to warn the operator to read the user and maintenance manual (this document) before using the appliance. It also shows certain procedures to be applied for the proper care of the appliance.
	<b>Solution tank filter daily care warning label:</b> Affixed to the appliance in order to remind the operator to clean the solution tank filter after each use of the appliance.
	<b>Warning label (versions with on-board battery charger):</b> Affixed to the appliance in order to warn the operator to read the user and maintenance manual (this document) before using the appliance. It also contains a <b>summary</b> of the procedures to be applied in order to properly charge the batteries.
	<b>Warning label (versions with on-board battery charger):</b> Used on the appliance to advise the operator of the procedures to be applied in order to properly care for the appliance.
	<b>pH label (versions with on-board CDS system):</b> Affixed above the detergent tank to indicate the pH range of the detergent to be utilized.
	<b>Percentage of detergent use label (versions with on-board CDS system):</b> Affixed near the detergent tank to indicate the usage instructions for standard or concentrated detergents.



**Water system use warning label (versions with on-board CDS):**  
Affixed to the appliance in order to warn the operator to read the user and maintenance manual (this document) before using the appliance with the automatic detergent solution dosing system.

### SYMBOLS USED ON THE INSTRUMENT PANEL (version B)

	<b>Main switch symbol:</b> This is used on the back of the appliance to indicate the main switch.
	<b>Symbol of battery charge level:</b> Used on the instrument panel, to indicate the battery charge level display.
	<b>Symbol of brush gearmotor control switch:</b> Used on the instrument panel to indicate the brush gearmotor control switch.
	<b>Symbol of vacuum motor control switch:</b> Used on the instrument panel to indicate the vacuum motor control switch.
	<b>Symbol of solenoid valve control switch:</b> Used on the instrument panel to indicate the control switch for the solenoid valve in the brush head body of the appliance.

### SYMBOLS USED ON THE INSTRUMENT PANEL (versions BT - BTS - BTO)

	<b>Main switch symbol:</b> This is used on the back of the appliance to indicate the main switch.
	<b>Traction motor potentiometer symbol:</b> Used on the control panel to indicate the knob that commands the potentiometer that controls the traction motor.
	<b>Symbol for ECO-MODE program:</b> Used on the control panel to indicate the switch for activating the ECO-MODE program.
	<b>Symbol of the reverse movement selector:</b> Used on the control panel to indicate the button for engaging the reverse gear.
	<b>Brush release symbol:</b> Used on the control panel to indicate the button for releasing the brush automatically.
	<b>Brush head control symbol (versions with PM system):</b> Used on the control panel to indicate the brush head command button of the appliance.
	<b>Water level adjustment symbol (versions with CDS system):</b> Used on the control panel to indicate the button for adjusting the water level in the device water circuit.
	<b>Detergent percentage adjustment symbol (versions with CDS system):</b> Used on the control panel to indicate the button for adjusting the percentage of detergent in the device water circuit.
	<b>Vacuum wand control symbol (versions with SST system):</b> Used on the control panel to indicate the button for controlling the vacuum wand.
	<b>Spray gun control symbol (versions with SST system):</b> Used on the control panel to indicate the button for controlling the spray gun.

### DISPLAY SCREENS (versions BT - BTS - BTO)



The adjacent image identifies the "WORK PANEL" screen, the icon in the top right corresponds to the charge level of the batteries.

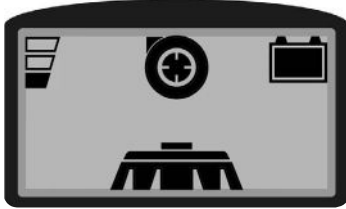

The adjacent image shows the "SCRUBBING AND DRYING" work screen for the BT - BTO versions. The symbol in the middle of the screen identifies the type of work being carried out. In this case, both the brush head unit and the squeegee unit are in contact with the ground. The working program selected is the standard one.

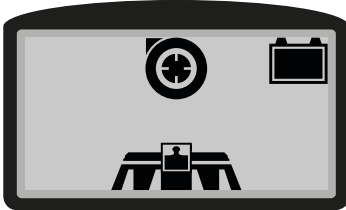

The adjacent image shows the "SCRUBBING AND DRYING with EXTRA PRESSURE" work screen for the PM versions. The symbol in the middle of the screen identifies the type of work being carried out. In this case, both the brush head unit and the squeegee unit are in contact with the ground. The extra pressure is exerted on the brush head body.

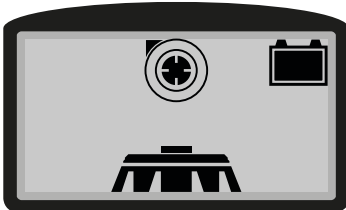

The adjacent image shows the "SCRUBBING AND DRYING IN ECO-MODE" work screen for the BT - BTO versions. The symbol in the middle of the screen identifies the type of work being carried out. In this case, both the brush head unit and the squeegee unit are in contact with the ground. The working program selected is eco-mode.

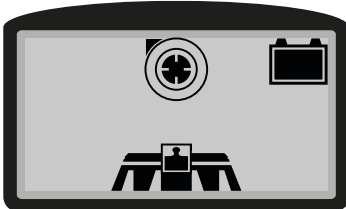

The adjacent image shows the "SCRUBBING AND DRYING IN ECO-MODE with EXTRA PRESSURE" work screen for the PM versions. The symbol in the middle of the screen identifies the type of work being carried out. In this case, both the brush head unit and the squeegee unit are in contact with the ground. The extra pressure is exerted on the brush head body.



The adjacent image shows the "SCRUBBING AND DRYING" work screen for the BTS versions. The symbol in the middle of the screen identifies the type of work being carried out. In this case, both the brush head unit and the squeegee unit are in contact with the ground. The working program selected is the standard one.

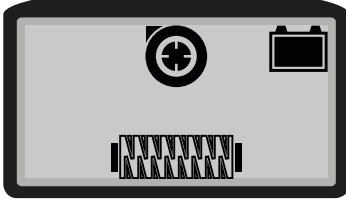

The adjacent image shows the "SCRUBBING AND DRYING IN ECO-MODE" work screen for the BTS versions. The symbol in the middle of the screen identifies the type of work being carried out. In this case, both the brush head unit and the squeegee unit are in contact with the ground. The working program selected is eco-mode.



The adjacent image shows the "SCRUBBING ONLY" work screen for the BT - BTO versions. The symbol in the middle of the screen identifies the type of work being carried out. In this case, only the brush head unit is in contact with the ground. The squeegee unit is in its idle position. The working program selected is the standard one.

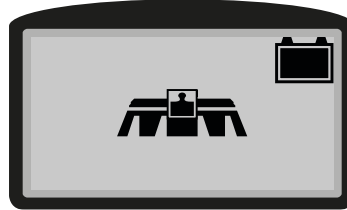

The adjacent image shows the "SCRUBBING ONLY" work screen for the PM versions. The symbol in the middle of the screen identifies the type of work being carried out. In this case, only the brush head unit is in contact with the ground. The squeegee unit is in its idle position. The extra pressure is exerted on the brush head body.



The adjacent image shows the "SCRUBBING ONLY" work screen for the BTS versions. The symbol in the middle of the screen identifies the type of work being carried out. In this case, only the brush head unit is in contact with the ground. The working program selected is the standard one.

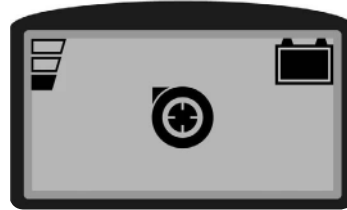

The adjacent image shows the "DRYING ONLY" work screen. The symbol in the middle of the screen identifies the type of work being carried out. In this case, only the squeegee unit is in contact with the ground. The brush head unit is in its idle position. The working program selected is the standard one.

**! The drying without scrubbing operation should only be carried out if beforehand the device was used to carry out scrubbing without drying.**



The adjacent image shows the "ECO-MODE DRYING ONLY" work screen. The symbol in the middle of the screen identifies the type of work being carried out. In this case, only the squeegee unit is in contact with the ground. The brush head unit is in its idle position. The working program selected is eco-mode.

**! The drying without scrubbing operation should only be carried out if beforehand the device was used to carry out scrubbing without drying.**



The adjacent image shows the "CRITICAL BATTERY CHARGE LEVEL" warning screen. The symbol in the middle of the screen indicates that the battery charge has reached a critical level. The remaining charge is sufficient for completing the drying task before recharging the batteries.

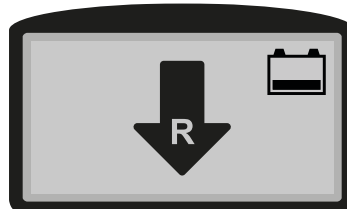

The adjacent image indicates that "REVERSE" movement is being used. The symbol in the middle of the screen indicates that reverse movement is currently being used.

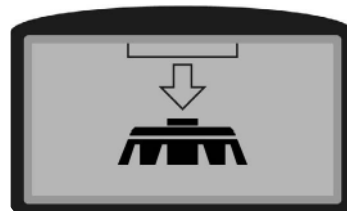

The adjacent image indicates the "BRUSH RELEASE" for the BT versions. The symbol in the middle of the screen indicates the activation of the sequence for releasing the brush from the brush-holder plate on the brush head.

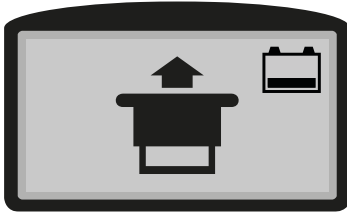

The adjacent image identifies "EMERGENCY SWITCH ACTIVE".

The symbol in the middle of the screen indicates that currently the emergency button has been activated.

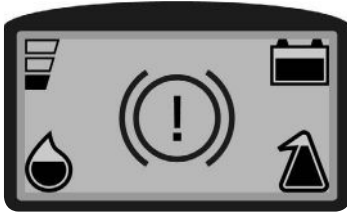

The adjacent image indicates "ELECTRONIC BRAKE DISENGAGED".

The symbol that appears in the middle of the screen indicates that the appliance's electric brake is not currently engaged.

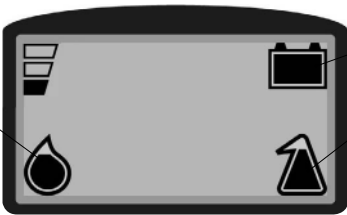

The adjacent image shows the "WORKING PANEL (CDS version)" screen, with the following elements identified:

1. This icon shows the batteries' charge level.
2. This icon shows the percentage of chemical detergent present in the detergent solution.
3. This icon shows the amount of water present in the detergent solution.

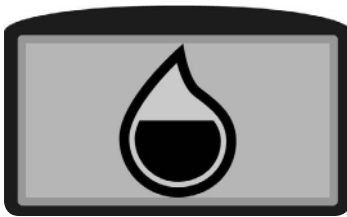

The adjacent image shows "WATER LEVEL ADJUSTMENT" in the water circuit (versions with CDS).

The symbol in the middle of the screen indicates that the amount of water in the device water circuit is being adjusted.

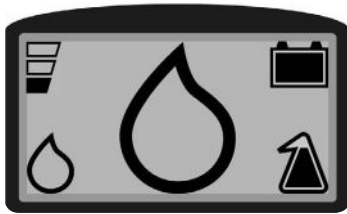

The adjacent image shows "WATER LEVEL AT ZERO" in the water circuit (versions with CDS).

The symbol in the middle of the screen indicates that the amount of water in the device water circuit is currently at zero.



The adjacent image shows "DETERGENT PERCENTAGE ADJUSTMENT" in the water circuit (versions with CDS).

The symbol in the middle of the screen indicates that the percentage of detergent in the device water circuit is being adjusted.

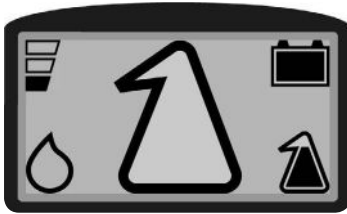

The adjacent image shows "DETERGENT PERCENTAGE AT ZERO" in the water circuit (versions with CDS).

The symbol in the middle of the screen indicates that the percentage of detergent in the device water circuit is currently at zero.

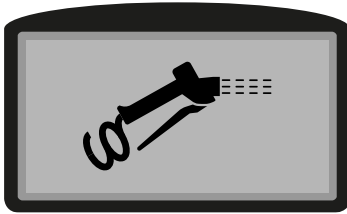

The adjacent image shows the "SPRAY GUN KIT ACTIVATION" only for SST versions.

The symbol in the middle of the screen indicates that the spray gun kit is currently active.

## PREPARING THE APPLIANCE

### HANDLING THE PACKED APPLIANCE

Since the packaging elements (plastic bags, staples, etc.) are a potential source of danger, they should not be left within the reach of children, disabled persons, etc.

Gross weight of device, including packaging, is:

- 95Kg for the Antea 50B
- 100Kg for the Antea 50BTS
- 105Kg for the Antea 50 BT-BTO
- 115Kg for the Versa 55-65 BT
- 000Kg for the Versa 60BTS

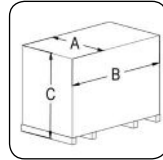

The packaging dimensions are:

- A=610mm B=1250mm C=1135mm for Antea 50 B-BT-BTO
- A=730mm B=1330mm C=1220mm for Antea 50BTS and Versa 55-65 BT

**i** **N.B.:** it is recommended that all the packaging components be kept for any future transportation of the appliance.

**DANGER:** move the packaged product with handling equipment that complies with legal requirements regarding size and mass of the packaging.

### HOW TO UNPACK THE APPLIANCE (versions without PM)

The appliance is enclosed within special packaging; to remove the appliance from the packaging proceed as follows:

1. Place the lower part of the outer packaging in contact with the floor.

**i** **N.B.:** Use the pictograms printed on the box as reference.

2. Remove the outer package.

**CAUTION:** these operations must be carried out using protective gloves to avoid any possible contact with the edges or tips of metal objects.

3. Raise the brush head unit and press the brush head control pedal (1) (on the rear of the device) downwards (Fig. 1).
4. Raise the squeegee unit and turn the squeegee control lever (2) in the direction of the arrow in (Fig. 2). The lever is located on the back of the device.
5. The device is fixed to the pallet by means of wedges (3) that block the wheels and brush head (Fig. 3). Remove the wedges.

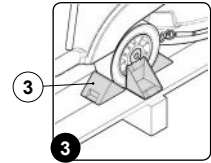
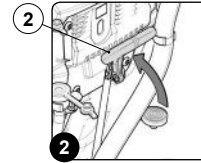
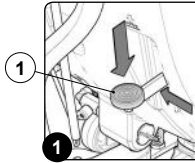

6. For BT versions, release the electronic brake and turn the lever (4) in the direction of the arrow. The traction gearmotor is located on the left side of the device (Fig. 4).

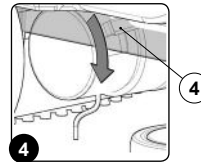

7. Using a chute, bring the device down from the pallet, pushing it backwards.

**i** **N.B.:** Do not fit the brush and the rear squeegee unit before unloading the device, and avoid any violent jolts to the brush head and the squeegee support.

**i** **N.B.:** during the operation to move it by pushing, the electric brake should not be engaged. The device will anyway have safety braking, once a set critical speed has been exceeded the internal braking system of the chopper circuit board will activate automatically.

### HOW TO UNPACK THE APPLIANCE (versions with PM)

The appliance is enclosed within special packaging; to remove the appliance from the packaging proceed as follows:

1. Place the lower part of the outer packaging in contact with the floor.

**i** **N.B.:** Use the pictograms printed on the box as reference.

2. Remove the outer package.

**CAUTION:** these operations must be carried out using protective gloves to avoid any possible contact with the edges or tips of metal objects.

3. Check that the appliance is off, if not, set the main switch (1) to "0", turning the key (2) a quarter of a turn to the left (Fig. 1). Remove the key from the instrument panel.

4. Grip the handle (3) on the left side of the recovery tank (Fig. 2) and turn the tank as far as it will go in the maintenance position (Fig. 3).

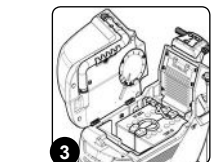
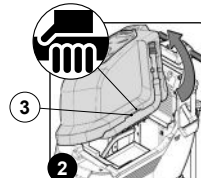
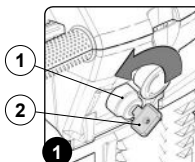

5. Connect the battery hopper connector (4) to the connector of the general system (5) (Fig. 4).

**WARNING:** This process must be carried out by qualified personnel.

6. Grip the handle (3) on the left side of the recovery tank and turn the tank until it reaches the work position (Fig. 5).  
7. The device is fixed to the pallet by two wedges (6) that block the wheels and brush head (Fig. 6). Remove the wedges.

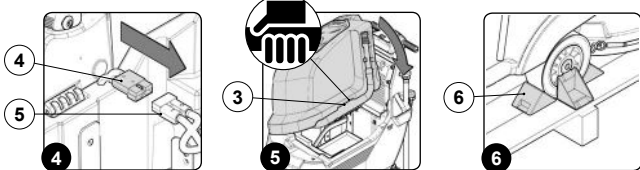

8. Start the appliance, turn the main switch (1) to "I", making a quarter turn to the right with the key (2) (Fig. 7)).  
9. Lift the brush head body, press the "BRUSH HEAD COMMAND" button (7) on the control panel (Fig. 8).  
10. Raise the squeegee unit and turn the squeegee control lever (8) in the direction of the arrow in (Fig. 9). The lever is located on the back of the device.

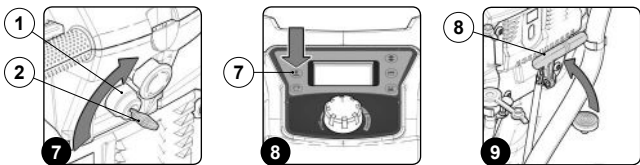

11. Press the "REVERSE ACTIVATION - DEACTIVATION" button (9) on the control panel (Fig. 10).

**N.B.:** as soon as you press the button (9) on the control panel (Fig. 10), the control display will show the "REVERSE" screen (Fig. 11).

12. Engage the dead man's levers (10) on the handlebar (Fig. 12) to start moving the appliance in reverse.

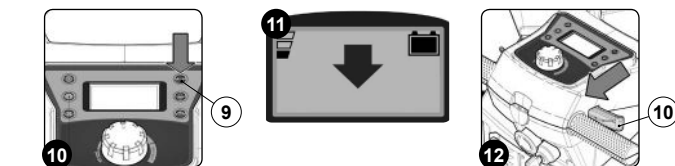

13. Using a chute, bring the device down from the pallet, pushing it backwards.

**N.B.:** Do not fit the brush and the rear squeegee unit before unloading the device, and avoid any violent jolts to the brush head and the squeegee support.

14. Turn off the appliance, turning the main machine switch (1) to "0", and turn the key (2) a quarter turn to the left (Fig. 1). Remove the key from the instrument panel.  
15. Grip the handle (3) on the left side of the recovery tank (Fig. 2) and turn the tank as far as it will go in the maintenance position (Fig. 3).  
16. Disconnect the battery hopper connector (4) from the connector of the general system (5) (Fig. 13).

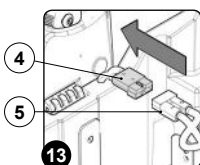

**WARNING:** This process must be carried out by qualified personnel.

17. Grip the handle (3) on the left side of the recovery tank and turn the tank until it reaches the work position (Fig. 5).

### HOW TO TRANSPORT THE APPLIANCE

To transport the machine, proceed as follows:

1. Check that the solution tank and recovery tank are empty, and empty them if necessary (see the paragraph "EMPTYING THE RECOVERY TANK" or read the paragraph "EMPTYING THE SOLUTION TANK").  
2. For B versions, make sure the device is switched off. If it isn't, press the main switch (1) on the back of the device (Fig. 1).

**N.B.:** in B versions, the main switch (1) is in the idle position when the LED inside it is OFF and the activation symbol is not visible.

3. For BT versions, make sure the device is switched off. If it isn't, bring the main switch (2) to the "0" position by making a quarter turn to the left with the key (3) (Fig. 2). Remove the key from the instrument panel.

4. Grip the handle (4) on the left side of the recovery tank (Fig. 3) and turn the tank as far as it will go, until it reaches the maintenance position (Fig. 4).

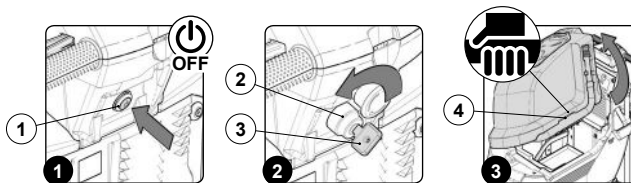

5. Disconnect the connector of the general system (5) from the connector of the batteries (6) (Fig. 5).

**WARNING:** This process must be carried out by qualified personnel.

6. Grip the handle on the left side of the recovery tank and turn the tank until it reaches the work position (Fig. 6).

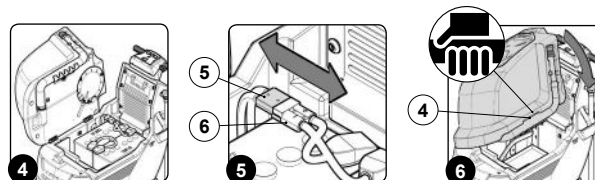

7. For BT versions, release the electronic brake and turn the lever (7) in the direction of the arrow. The traction gearmotor is located on the left side of the device (Fig. 7).

8. Using a chute, slide the machine onto the pallet.

9. For BT versions, engage the electronic brake and turn the lever (7) in the direction of the arrow. The traction gearmotor is located on the left side of the device (Fig. 8).

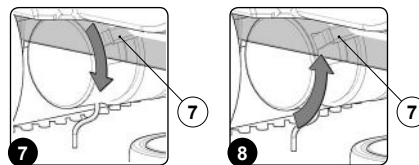

10. Secure the device to the pallet using the wedges.

**WARNING:** for transportation without a pallet, secure the device according to the directives in force in the country of use so that it does not slide or tip over.

### COMPONENT POSITIONING

The basic components of the appliance are as follows:

1. Knob for adjusting the work speed (B versions) (Fig. 1).
2. Recovery tank outlet pipe (Fig. 2).
3. Handle for raising the recovery tank (Fig. 2).
4. Solution tank cap/measuring device (Fig. 3).
5. Tube for quick filling of the solution tank (Fig. 3).

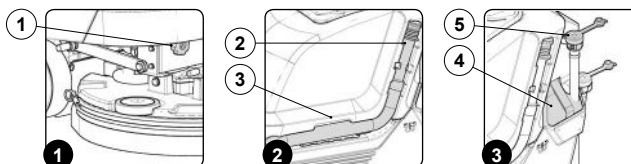

6. Tube for solution tank level/drainage (Fig. 4).
7. Handle for raising the squeegee unit (Fig. 4).
8. Rod for adjusting the detergent solution flow (Fig. 4).
9. Tap control lever (Fig. 5).
10. Squeegee unit vacuum hose (Fig. 5).
11. Brush head control pedal (Fig. 6).
12. Solution tank cap/filter (Fig. 6).

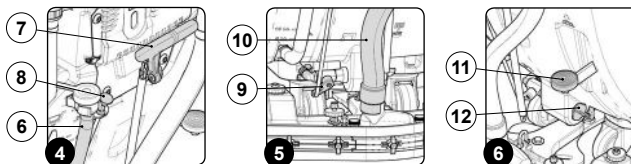

13. Hour meter display (B versions) (Fig. 7).
14. Battery charge level display (B versions) (Fig. 7).
15. Button for switching brush head gearmotor ON and OFF (B versions) (Fig. 7).
16. Button for switching vacuum motor ON and OFF (B versions) (Fig. 7).
17. Button for switching water system solenoid valve ON and OFF (B versions) (Fig. 7).
18. Dead man's lever (Fig. 7).
19. Handlebar (Fig. 7).
20. Main switch (B versions) (Fig. 7).
21. Control display (BT versions) (Fig. 8).
22. ECO-MODE program selection button (BT versions) (Fig. 8).
23. Button for adjusting the water flow in the device water system (valid only for BT versions with CDS) (Fig. 8).
24. Button for enabling or disabling reverse mode (BT versions) (Fig. 8).
25. Brush release button (BT versions) (Fig. 8).
26. Button for adjusting the detergent solution percentage in the device water system (valid only for BT versions with CDS) (Fig. 8).



- 27. Knob for adjusting the operation control potentiometer (BT versions) (Fig. 8).
- 28. Dead man's lever (Fig. 8).
- 29. Handlebar (Fig. 8).
- 30. Key switch for controlling the main system (BT versions) (Fig. 8).
- 31. Emergency button (BT versions) (Fig. 8).
- 32. Recovery tank cover (Fig. 9).
- 33. Storage compartment (Fig. 9).

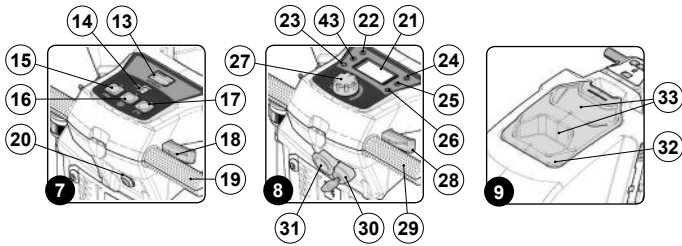

- 34. Cap for battery charger socket (battery charger versions only) (Fig. 10).
- 35. Battery charge LED display (battery charger versions only) (Fig. 10).
- 36. Electronic brake lever (BT versions only) (Fig. 11).
- 37. Brush head carter (Antea 50 BTS) (Fig. 12).
- 38. Right side splash guard retainer knob (Antea 50 BTS) (Fig. 12).
- 39. Right side splash guard (Antea 50 BTS) (Fig. 12).
- 40. Front brush hub (Antea 50 BTS) (Fig. 12).
- 41. Rear brush hub (Antea 50 BTS) (Fig. 12).
- 42. Debris hopper (Antea 50 BTS) (Fig. 12).

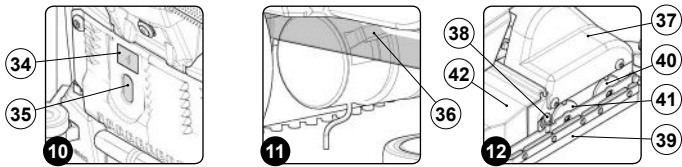

- 43. Brush head control button, only for versions with PM (Fig. 8).
- 44. Brush head left carter (Versa 65 BT) (Fig. 13).
- 45. Brush head right carter (Versa 65 BT) (Fig. 13).
- 46. Brush head (Versa 65 BT) (Fig. 13).
- 47. Brush holder flange locking pin (Versa 65 BT) (Fig. 13).
- 48. Brush head carter (Versa 65 BTS) (Fig. 14).
- 49. Brush head side splash guard (Versa 65 BTS) (Fig. 14).
- 50. Brush support hub (Versa 65 BTS) (Fig. 14).
- 51. Debris hopper (Versa 65 BTS) (Fig. 14).
- 52. Spray gun kit delivery pipe quick-coupler (SST versions) (Fig. 15).
- 53. Spray gun kit accessory (SST versions) (Fig. 15).
- 54. Vacuum wand accessory (SST versions) (Fig. 15).

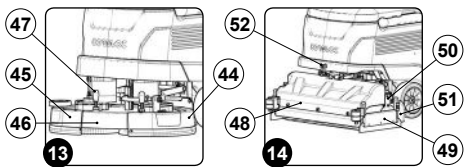

### APPLIANCE SAFETY

The stages for making the appliance safe, and thereby allowing all the operations to be carried out in complete safety, are as follows:

1. For BT versions, make sure the electronic brake is engaged by turning the lever (1) in the rear right part of the machine counter-clockwise (Fig. 1).
2. Check that the recovery tank is empty. If it isn't, empty it using the tube (2) on the left side of the machine (Fig. 2) (read the paragraph "EMPTYING THE RECOVERY TANK").

**ATTENTION:** The tanks should be emptied in the place used for draining dirty water.

**N.B.:** the place designated for this operation must comply with current environmental protection regulations.

3. For B versions, make sure the device is switched off. If it isn't, press the main switch (3) on the back of the device (Fig. 3).

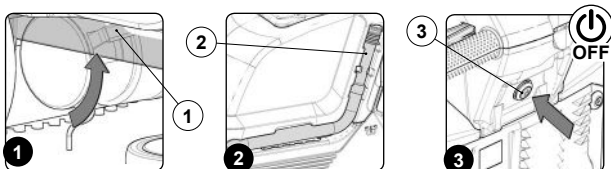

**N.B.:** in B versions, the main switch (3) is in the idle position when the LED inside it is OFF and the activation symbol is not visible.

4. For versions with PM, start the appliance, turn the main switch (4) to "I", making a quarter turn to the right with the key (5) (Fig. 4).
5. Lift the brush head body off the floor and press the "BRUSH HEAD CONTROL" button (6) on the control panel (Fig. 5).

6. For BT and PM versions, switch off the machine by bringing the main switch (4) to "0" and making a quarter turn to the left with the key (5) (Fig. 6). Remove the key from the instrument panel.

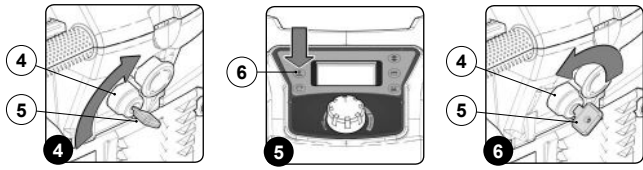

7. For versions without PM, lift the brush head off the floor, using the brush head control pedal (7) (Fig. 7).
8. Raise the squeezegee off the floor, turn the squeezegee control lever (8) counter-clockwise (Fig. 8).
9. Grip the handle (9) on the left side of the recovery tank (Fig. 9) and turn the tank as far as it will go, the maintenance position (Fig. 10).

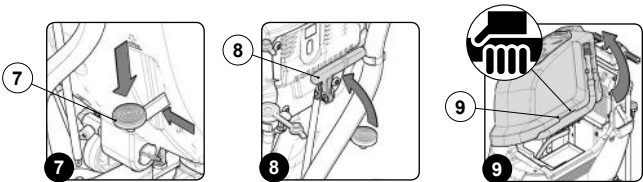

10. Disconnect the general system connector (10) from the connector of the batteries (11) (Fig. 11).

**WARNING:** This process must be carried out by qualified personnel.

11. Grip the handle on the left side of the recovery tank and turn the tank until it reaches the work position (Fig. 12).

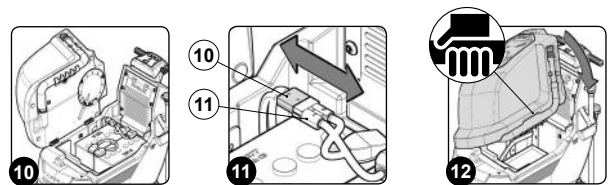

**WARNING:** make sure the battery charger supply cable is disconnected from the mains socket.

### TYPE OF BATTERY TO BE USED

Power to the machine must be supplied by two sealed traction batteries with gas recombination or gel technology.

The batteries must meet the requirements laid out in the norms: CEI EN 60254-1:2005-12 (CEI 21-5) + CEI EN 60254-2:2008-06 (CEI 21-7). For a good operating performance, we suggest the use of two 12V MFP 77 Ah/C5 batteries.

### BATTERY MAINTENANCE AND DISPOSAL

For maintenance and recharging, respect the instructions provided by the battery manufacturer. When the battery reaches the end of its working life, it must be disconnected by expert, trained personnel then removed from the battery compartment with the aid of suitable lifting devices.

**N.B.:** dead batteries are classified as dangerous waste and as such must be delivered to an authorised body for disposal.

### INSERTING BATTERIES INTO THE DEVICE

The batteries must be housed in the special compartment beneath the recovery tank and should be handled using lifting equipment that is suitable in terms of both weight and its coupling system.

**WARNING:** make sure that you comply with the accident prevention regulations in force in the country where you work or with DIN EN 50272-3 and DIN EN 50110-1, before any handling of the batteries.

**WARNING:** to prevent an accidental short circuit use insulated tools to connect the batteries, and do not place or drop metal objects on the battery. Remove rings, watches and any clothing with metal parts that may come into contact with the battery terminals.

The various phases for inserting the batteries in the battery compartment are as follows:

1. For BT versions, make sure the electronic brake is engaged by turning the lever (1) in the rear right part of the machine counter-clockwise (Fig. 1).
2. Check that the recovery tank is empty. If it isn't, empty it using the tube (2) on the left side of the machine (Fig. 2) (read the paragraph "EMPTYING THE RECOVERY TANK").

**N.B.:** The tanks should be emptied in the place used for draining dirty water.

**N.B.:** the place designated for this operation must comply with current environmental protection regulations.

- For B versions, make sure the device is switched off. If it isn't, press the main switch (3) on the back of the device (Fig. 3).

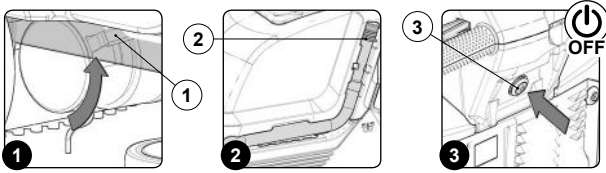

**!** *N.B.:* in B versions, the main switch (3) is in the idle position when the LED inside it is OFF and the activation symbol is not visible.

- For BT versions, make sure the device is switched off. If it isn't, set the main switch (4) to "0" by making a quarter turn with the key (5) (Fig. 4). Remove the key from the instrument panel.
- Grip the handle (6) on the left side of the recovery tank (Fig. 5) and turn the tank as far as it will go, until it reaches the maintenance position (Fig. 6).

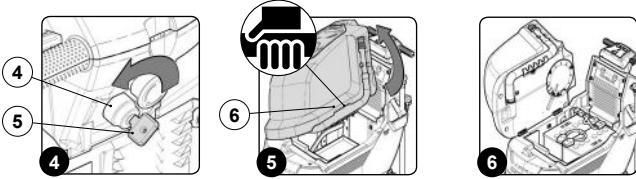

**i** *N.B.:* for battery maintenance and daily recharging, you must fully respect the indications provided by the manufacturer or retailer.

**!** **WARNING:** all installation and maintenance operations must be carried out by specialised personnel.

**i** **WARNING:** before installing the battery, clean the battery compartment. Check that the connectors on the cables supplied are functioning correctly.

**!** **WARNING:** check that the characteristics of the battery that you are looking to use are appropriate for the type of work to be performed. Check the battery charge and the condition of the contacts on the battery.

**i** **CAUTION:** you are advised to only lift and move the batteries with lifting and transportation means suitable for the specific weight and size.

**!** **ATTENTION:** the lifting hooks must not damage the blocks, connectors or cables.

**i** *N.B.:* before inserting the batteries, remember to cover the terminals with a little grease to protect them against external corrosion.

- House the batteries in the compartment, positioning the poles "+" and "-" opposite each other (Fig. 7).



### CONNECTING BATTERIES TO THE SYSTEM OF THE APPLIANCE

The batteries should be connected so as to obtain a total voltage of 24V.

**!** **WARNING:** it is recommended that all installation and maintenance operations be carried out by expert personnel, trained at the specialised assistance centre.

**!** **WARNING:** to prevent an accidental short circuit use insulated tools to connect the batteries, and do not place or drop metal objects on the battery. Remove rings, watches and any clothing with metal parts that may come into contact with the battery terminals.

The various phases for inserting the batteries in the battery compartment are as follows:

- Using the jumper cable supplied (1), connect the "+" and "-" poles of the batteries in series (Fig. 1).
- Connect the battery connector cable (2) to the "+" and "-" poles to obtain a voltage of 24V on the terminals (Fig. 2).
- Connect the battery connector (2) to the electric system connector (3) (Fig. 3).

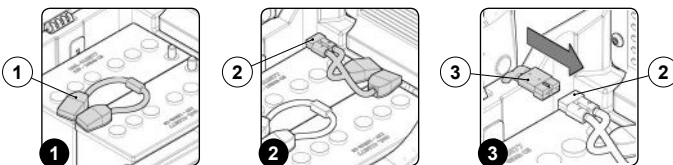

### RECHARGING THE BATTERIES

The battery must be charged prior to the first use, and when it doesn't provide enough power for tasks that could formerly be performed without difficulty.

**!** **WARNING:** to avoid any permanent damage to the batteries, it is essential to avoid their complete discharge; begin recharging them within a few minutes of noting the "discharged batteries" signal.

**i** *N.B.:* never leave the batteries completely discharged, even if the device is not being used.

To recharge the batteries without the built-in battery charger, proceed as follows:

- Bring the appliance to the zone where the batteries are charged.
- Take all necessary steps to ensure that the device is in a safe condition (see "MACHINE SAFETY").

**!** **WARNING:** park the appliance in an enclosed place, on a flat surface; near the appliance there must be no objects that could either damage it, or be damaged through contact with it.

**!** **WARNING:** the room used to recharge the batteries must be adequately ventilated to prevent the accumulation of gases that leak from batteries.

- Grip the handle (1) on the left side of the recovery tank (Fig. 1).
- Turn the recovery tank up to the end stop, maintenance position (Fig. 2).
- Disconnect the electric system connector (3) from the battery connector (2) (Fig. 3).

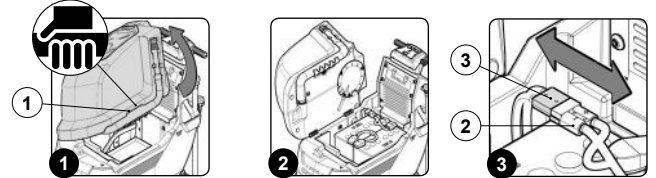

**!** **WARNING:** the following operations must be carried out by qualified personnel. An incorrect connection of the connector may cause a malfunction of the device.

- Connect the external battery charger cable connector (4) to the battery connector (2) (Fig. 4).

**i** *N.B.:* the coupling connector of the battery charger is consigned inside the bag containing this instruction booklet, and must be assembled on the cables of the battery charger as indicated in the instructions.

**!** **WARNING:** before connecting the batteries to the battery charger, make sure it is suitable for the batteries used.

**i** *N.B.:* carefully read the use and maintenance instructions of the battery charger that is used for charging.

**!** **WARNING:** keep the recovery tank open for the duration of the battery recharging cycle to allow gas fumes to escape.

- When the recharge cycle is complete, disconnect the battery charger cable connector (4) from the battery connector (2) (Fig. 5).
- Connect the electric system connector (3) to the battery connector (2) (Fig. 6).

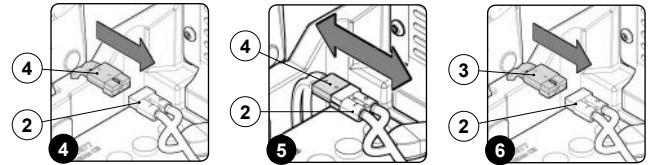

- Grip the handle (1) on the side of the recovery tank (Fig. 7).
- Turn the recovery tank as far as it will go, to the work position (Fig. 8).

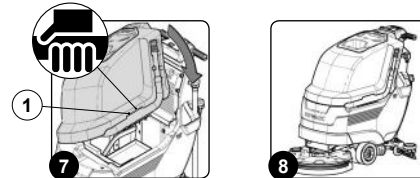

### RECHARGING THE BATTERIES (versions with CB system)

The battery must be charged prior to the first use, and when it doesn't provide enough power for tasks that could formerly be performed without difficulty.

**!** **ATTENTION:** to avoid any permanent damage to the batteries, it is essential to avoid their complete discharge; begin recharging them within a few minutes of noting the "discharged batteries" signal.

**i** *N.B.:* never leave the batteries completely discharged, even if the device is not being used.

To recharge the batteries with the on-board battery charger proceed as follows:

- Bring the appliance to the zone where the batteries are charged.
- Take all necessary steps to ensure that the device is in a safe condition (see "MACHINE SAFETY").

**!** **WARNING:** park the appliance in an enclosed place, on a flat surface; near the appliance there must be no objects that could either damage it, or be damaged through contact with it.

**!** **WARNING:** the room used to recharge the batteries must be adequately ventilated to prevent the accumulation of gases that leak from batteries.

- Grip the handle (1) on the left side of the recovery tank (Fig. 1).
- Turn the recovery tank up to the end stop, maintenance position (Fig. 2).

**!** **WARNING:** the following operations must be carried out by qualified personnel. An incorrect connection of the connector may cause a malfunction of the device.

**i** *N.B.:* Carefully read the use and maintenance instructions of the battery charger that is used for charging.

5. Connect the battery connector (2) to the electric system connector (3) (Fig. 3).

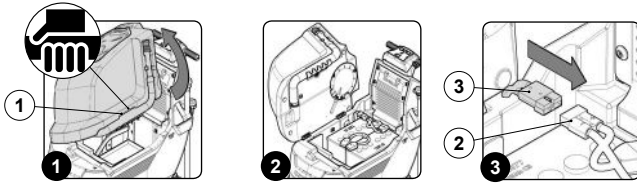

6. Remove the cap (4) from the battery charger socket (Fig. 4).

**i** **N.B.:** Before connecting the batteries to the battery charger, make sure it is suitable for the batteries used.

**i** **N.B.:** Before inserting the battery charger power cable in the socket (5), make sure there is no condensate or other types of liquid (Fig. 5).

**i** **N.B.:** the battery charger power cable is delivered inside the bag containing this instruction booklet.

7. Connect the connector of the battery charger power cable (6) to the socket in the charger itself (Fig. 6).

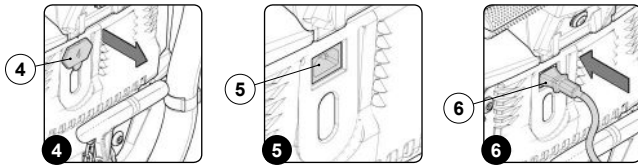

8. Plug the battery charger cable into the mains socket.

**i** **N.B.:** Keep the recovery tank open for the duration of the battery recharging cycle to allow gas fumes to escape.

9. When the recharge cycle is complete, disconnect the battery charger cable from the mains.

10. Disconnect the connector of the battery charger power cable (6) from the socket in the charger itself (Fig. 7).

11. Insert the cap (4) on the battery charger socket (Fig. 8).

12. Grip the handle (1) on the side of the recovery tank (Fig. 9).

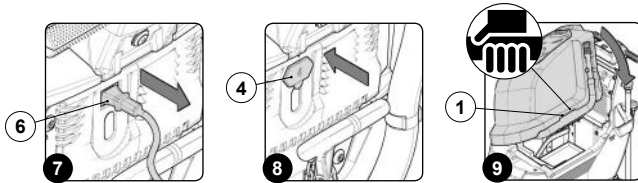

13. Turn the recovery tank as far as it will go, to the work position (Fig. 10).

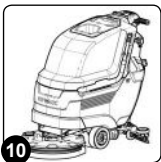

#### BATTERY CHARGE LEVEL INDICATOR (B versions)

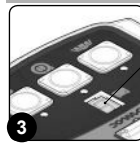

The instrument panel contains the display (3) indicating the battery charge status (Fig. 3). The battery charge level is represented by five numbers from 0 to 4, where 0 corresponds to a critical charge level and 4 corresponds to a fully charged battery.

**i** **N.B.:** A few seconds after the battery charge reaches the critical level, the brush motor switches off automatically. With the remaining charge it is possible to complete the drying process before starting the recharge.

#### BATTERY CHARGE LEVEL INDICATOR (BT versions)

The device instrument panel contains the control display. At the top right of the work screen, there is a graphic symbol (01) representing the battery charge level indicator (Fig. 1). The indicator is composed of 5 charge levels, each of which represents about 20% of residual charge. With a residual charge of 20%, the graphic symbol starts to flash. After a few seconds it appears in larger dimensions in the middle of the screen (Fig. 2); at this point, you must take the machine to the designated recharging place.

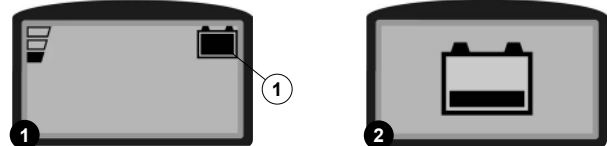

**i** **N.B.:** A few seconds after the battery charge level reaches 20%, the brush motor switches off automatically. With the remaining charge it is still possible, however, to complete the drying process before recharging.

**i** **N.B.:** A few seconds after the battery charge level reaches 10%, the vacuum motor switches off automatically. The remaining charge is sufficient for moving the appliance to the designated recharging place.

#### INSTALLING THE BRUSH (B - BT single brush versions)

For packaging reasons, the brush is supplied disassembled from the device. To assemble it on the brush head unit, proceed as follows:

1. Take all necessary steps to ensure that the device is in a safe condition (see "MACHINE SAFETY").

**CAUTION:** these operations must be carried out using protective gloves to avoid any possible contact with the edges or tips of metal objects.

2. If the brush head splash guard is present, release the brush head splash guards retainer spring (1) (Fig. 1).
3. Remove the retainer blade (2) and the splash guard (3) (Fig. 2).
4. With the brush head UP, insert the brush in the plate housing underneath the brush head, turning it until the three buttons engage with the niches on the plate itself. Turn until the pin is pushed towards the coupling spring and is locked into place. The photo (Fig. 3) shows the rotation direction for brush coupling.
5. Replace the splash guard, inserting first the rear left part and then the right part. Remember to fix it to the brush head using the retainer blade.
6. Fix the retainer blade to the brush head with the aid of the spring.

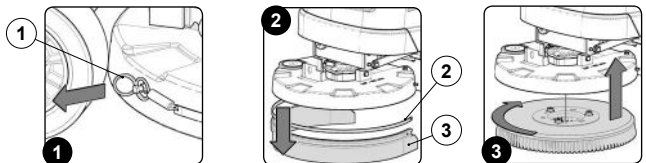

#### INSTALLING THE BRUSH HEAD BRUSH (B - BT single brush versions)

For packaging reasons, the brush head splash guard is supplied disassembled from the device, and must be assembled on the brush head unit as follows:

1. Take all necessary steps to ensure that the device is in a safe condition (see "MACHINE SAFETY").

**CAUTION:** these operations must be carried out using protective gloves to avoid any possible contact with the edges or tips of metal objects.

2. Release the brush head splash guards retainer spring (1) (Fig. 1).
3. Remove the retainer blade (2) (Fig. 2).
4. Fit the splash guard (Fig. 3), inserting first the left part and then the right part. Remember to fix it to the brush head using the retainer blade.
5. Fix the retainer blade to the brush head with the aid of the spring.

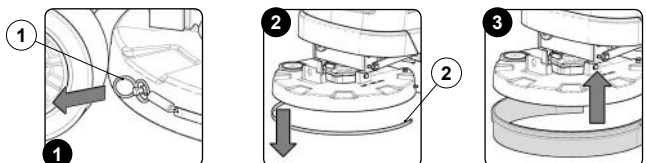

#### HOURLY METER (B versions)



The device's control panel contains the hour meter display (1), which shows the total usage time (Fig. 1). The digits that precede the "." symbol identify hours, whilst the digit that follows it indicates hour decimals (an hour decimal corresponds to six minutes). The flashing ":" symbol indicates that the hour meter is counting the appliance's operating time.

#### HOURLY METER (BT versions)

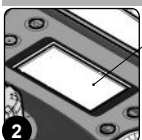

The device control panel contains the control display (2), which shows the total usage time (Fig. 2). The numbers before the letter "h" identify the hours, while the numbers before the letter "m" identify the tenths of an hour (a tenth of an hour corresponds to six minutes). The flashing ":" symbol indicates that the hour meter is counting the appliance's operating time.

### INSTALLING THE BRUSH (BT double brush versions)

For packaging reasons, the brush is supplied disassembled from the device. To assemble it on the brush head unit, proceed as follows:

1. Take all necessary steps to ensure that the device is in a safe condition (see "MACHINE SAFETY").
2. Position yourself at the rear of the appliance.
3. Lower the brush head unit by pressing the brush head control pedal (1) on the back of the appliance (Fig. 1).
4. Position yourself at the front of the appliance.
5. If the splash guard carters (2) are present, remove them (Fig. 2) and lay them gently on the ground.
6. Position yourself at the rear of the appliance.
7. Raise the brush head body off the floor and press the brush head control pedal (1) on the rear of the device (Fig. 3).

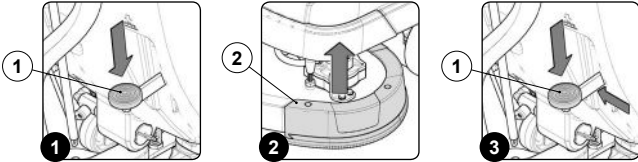

8. With the brush head UP, insert the brush in the plate housing underneath the brush head, turning it until the three buttons engage with the niches on the plate itself.
9. Press the brush-holder plate latch (3) and simultaneously rotate the brush (4) according to the direction indicated in the image (Fig. 4).

**i** N.B.: The image Fig. 4 shows the rotation direction of the left brush.

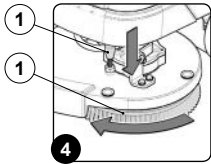

10. When brush rotation is prevented, turn until the button on the brush is engaged in the coupling spring on the brush-holder plate.
11. Reassemble the brush head splash guard carters.

### INSTALLING THE BRUSH HEAD BRUSH (BT double brush versions)

For packaging reasons, the brush head splash guard is supplied disassembled from the device, and must be assembled on the brush head unit as follows:

1. Take all necessary steps to ensure that the device is in a safe condition (see "MACHINE SAFETY").
- CAUTION:** these operations must be carried out using protective gloves to avoid any possible contact with the edges or tips of metal objects.
2. Position yourself at the front of the appliance.
3. Insert the pins (1) present on the left splash guard (2) (Fig. 1) into the holes (3) present in the brush head body (4) (Fig. 2).
4. Repeat the same operation for the right splash guard also.

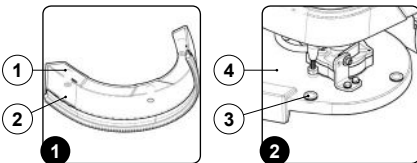

### INSTALLING THE BRUSH (50BTS double brush versions)

To assemble the brushes to brush head unit, which for reasons of packaging are supplied disassembled from the machine, proceed as follows:

1. Take all necessary steps to ensure that the device is in a safe condition (see "MACHINE SAFETY").
- CAUTION:** these operations must be carried out using protective gloves to avoid any possible contact with the edges or tips of metal objects.
2. Position yourself on the right-hand side of the appliance.
3. Loosen the retainer knob (1) (Fig. 1).
4. Remove the right side splash guard support (2), making sure to shift the blade before removing the splash guard support itself (Fig. 2).
5. Remove the rear brush guide hub (3) (Fig. 3).
6. Insert the rear brush into the tunnel, taking care to properly position the drive pins (4) on the guide hub (5) in the slits present on the brush (Fig. 4).

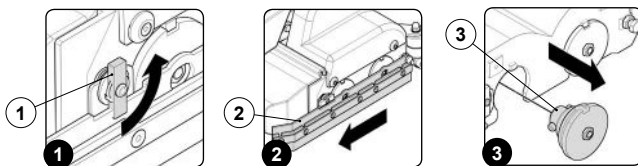

7. Insert the hub (3) into the brush, taking care to properly position the drive pins (6) in the slits on the brush (Fig. 5).

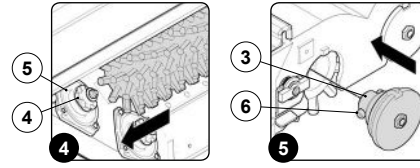

8. Repeat the operations described above for the front brush as well.

**i** N.B.: The rear brush (work direction) should always be the light blue one.

**i** N.B.: The brush bristles are properly positioned if they form an X when viewed from above. Both vertices, of the shortest height, should converge towards the centre.

9. Repeat the operations in reverse order to reassemble all the parts.

### INSTALLING THE BRUSH (65BTS double brush versions)

To assemble the brushes to brush head unit, which for reasons of packaging are supplied disassembled from the machine, proceed as follows:

1. Take all necessary steps to ensure that the device is in a safe condition (see "MACHINE SAFETY").
- CAUTION:** these operations must be carried out using protective gloves to avoid any possible contact with the edges or tips of metal objects.
2. Stand on the left side of the appliance.
3. Remove the left side splash guard support (1) (Fig. 1).
4. Remove the brush hub support carter (2) from the brush head body (Fig. 2), remember to move the retainer blade (3) downwards before removing the brush hub support (Fig. 3).

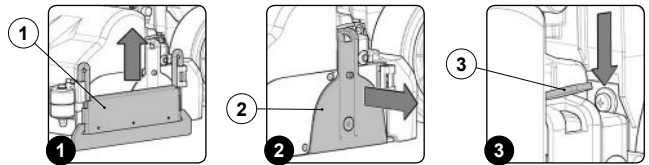

5. Insert the rear brush in the tunnel (Fig. 4), positioning the pentagonal driving pins (4) in the pentagonal slit (5) in the brush (Fig. 5).
6. Insert the brush hub support carter (2) into the brush head base (Fig. 6), correctly positioning the hexagonal pin (6) in the brush hub support into the hexagonal slit (7) in the brush (Fig. 7).

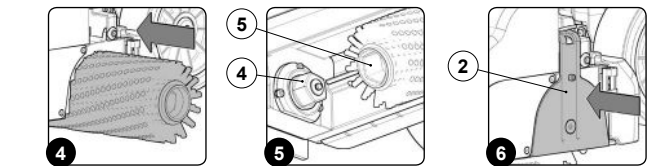

**i** N.B.: To fix the brush hub support carter to brush head body, insert the retainer blade (3) into the slot (8) in the brush hub support carter (Fig. 8).

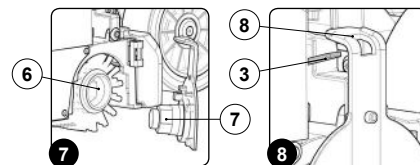

7. Repeat the operations described above for the front brush as well.

**i** N.B.: The brush bristles are properly positioned if they form an X when viewed from above. Both vertices, of the shortest height, should converge towards the centre.

8. Repeat the operations in reverse order to reassemble all the parts.

### INSTALLING THE ABRASIVE PAD (BTO versions)

For packaging reasons, the brush is supplied disassembled from the device. To assemble it on the brush head unit, proceed as follows:

1. Take all necessary steps to ensure that the device is in a safe condition (see "MACHINE SAFETY").
- CAUTION:** these operations must be carried out using protective gloves to avoid any possible contact with the edges or tips of metal objects.
2. With the brush head up, insert the abrasive pad in the lower part of the brush head (Fig. 1).

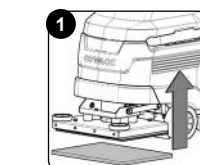

### ASSEMBLING THE SQUEEGEE BODY

For packaging reasons, the squeegee unit is supplied disassembled from the device, and must be assembled on the squeegee support as follows:

1. Take all necessary steps to ensure that the device is in a safe condition (see **"MACHINE SAFETY"**).

**CAUTION:** these operations must be carried out using protective gloves to avoid any possible contact with the edges or tips of metal objects.

2. Unscrew the knobs (1) in the squeegee body pre-assembly (Fig. 1).
3. First insert the left pin (2) on the squeegee body into the left slit (3) in the squeegee support (Fig. 2), making sure that the washer and spring adhere to the top of the squeegee support.
4. Insert the right pin (4) on the squeegee body into the right slit (5) in the squeegee support (Fig. 3), making sure that the washer and spring adhere to the top of the squeegee support.

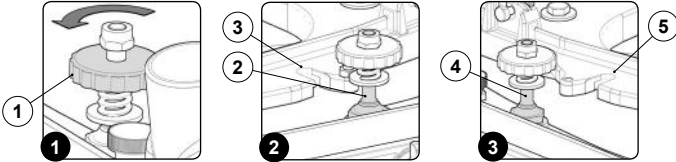

5. Tighten the knobs (1), ensuring that the washer and spring adhere to the top part of the squeegee support (Fig. 4).
6. Insert the vacuum tube (6) in the sleeve (7) in the squeegee body (Fig. 5).

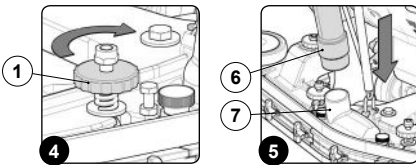

**N.B.:** the squeegee has been adjusted beforehand, nevertheless if it is necessary read the section **"ADJUSTING THE SQUEEGEE UNIT"**.

### FILLING THE SOLUTION TANK WITH WATER

Before filling the solution tank, carry out the following steps:

1. Take the machine to the dedicated solution tank filling area.
2. Take all necessary steps to ensure that the device is in a safe condition (see **"MACHINE SAFETY"**).
3. Check that the solution tank discharge cap (1) is open. If it isn't, open it (Fig. 1).
4. Check that the filter plug of the water system (2) at the rear right part of the machine, has been tightened, and if not turn it clockwise (Fig. 2).

The solution tank can be filled with water in three different ways:

- Removing the cap/measuring device (3) and filling the solution tank by means of a rubber hose or a bucket (Fig. 3).

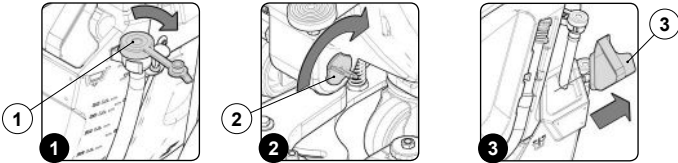

- Using the filler hose (4) (Fig. 4). This supports the water hose on its own, but be sure to remove the cap/measuring device (3) to allow adequate air venting.
- Using the optional system for automatic clean water top-up (5) (Fig. 5). This system has a float for avoiding any overflow.

5. Fill with clean water, at a temperature not higher than 50 °C and not lower than 10 °C. The amount inside the tank can be seen by means of the level tube (6) (Fig. 6) on the front left of the seat.

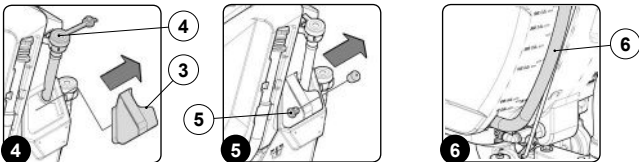

### ADJUSTING THE DETERGENT SOLUTION (versions without CDS system)

After filling the solution tank with clean water add the liquid detergent to the tank in the concentration and manner indicated on the detergent manufacturer's label. To prevent the formation of an excessive amount of foam that could damage the vacuum motor, use the minimum percentage of detergent required.

**CAUTION:** protective gloves should always be worn before handling detergents or acidic or alkaline solutions, to avoid serious injury to the hands.

**ATTENTION:** always use detergents whose manufacturer's label indicates their suitability for scrubbing machines. Do not use acid or alkaline products or solvents without this indication.

**ATTENTION:** acid or alkaline maintenance detergent tank be used with pH values between 4 and 10 and that do not contain: oxidising agents, chlorine or bromine, formaldehyde, mineral solvents. The detergents used must be suitable for use with scrubbing machines.

**NOTE:** always use low-foam detergent. To avoid the production of foam, put a minimum quantity of anti-foam liquid in the recovery tank before starting to clean. Do not use pure acids.

**N.B.:** to make it easier to measure the detergent on the cap/measuring device, there are two notches indicating the two main detergent percentage quantities that can be used.

### FILLING THE DETERGENT CANISTER (versions with CDS system)

After filling the solution tank with clean water, you must fill the detergent canister. Before filling the canister, carry out the following steps:

1. Take the machine to the dedicated solution tank filling area.
2. Take all necessary steps to ensure that the device is in a safe condition (see **"MACHINE SAFETY"**).
3. Grip the handle (1) on the left side of the recovery tank (Fig. 1) and turn the tank as far as it will go, until it reaches the maintenance position (Fig. 2).
4. Disconnect the male insert (2) from the female insert (3) present on the cap (4) for the detergent tank (5) (Fig. 3).

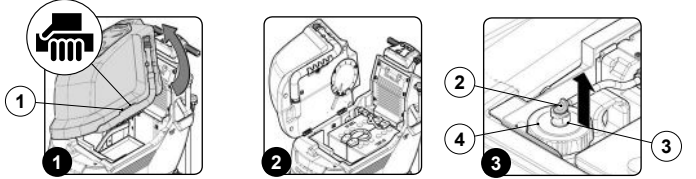

**N.B.:** before pulling on the male insert, push the lever on the female insert.

5. Gripping the handle (6) on the detergent canister (5), remove the canister from the compartment in the solution tank (Fig. 4).
6. Remove the cap (4) from the detergent canister (Fig. 5).
7. Fill the canister with the desired detergent, as shown on the label supplied with the appliance.

**CAUTION:** protective gloves should always be worn before handling detergents or acidic or alkaline solutions, to avoid serious injury to the hands.

**N.B.:** always use low-foam detergent. To avoid the production of foam, put a minimum quantity of anti-foam liquid in the recovery tank before starting to clean. Do not use pure acids.

**ATTENTION:** always use detergents whose manufacturer's label indicates their suitability for scrubbing machines. Do not use acid or alkaline products or solvents without this indication.

**ATTENTION:** the dosing system is suitable for frequent maintenance cleaning. Acid or alkaline maintenance detergent tank be used with pH values between 4 and 10 and that do not contain: oxidising agents, chlorine or bromine, formaldehyde, mineral solvents. The detergents used must be suitable for use with scrubbing machines. Wash the circuit with water after use if the system is not used daily. The system can be excluded. In case of sporadic use of detergents with pH between 1-3 or 11-14, use the floor scrubbing machine in the traditional way by adding the detergent in the clean water tank and excluding the dosing circuit.

8. Make sure you tighten the cap (4) properly to avoid any liquid leaks during the work activities (Fig. 6). Also make sure that the detergent suction filter (7) is correctly positioned on the bottom of the canister (Fig. 7).

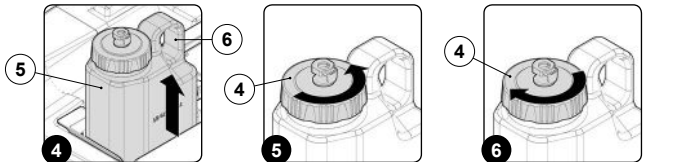

9. Gripping the canister handle (6), place the canister (5) back in its compartment inside the solution tank (Fig. 8).

10. Connect the male insert (2) to the female insert (3) present on the cap (4) for the detergent tank (5) (Fig. 9).

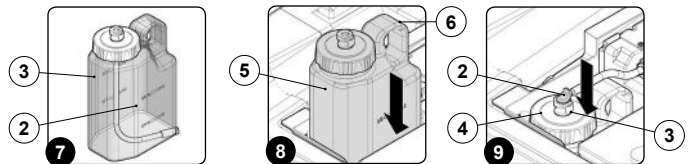

11. Grip the handle (1) on the left side of the recovery tank (Fig. 10) and turn the recovery tank as far as it will go, until it reaches the work position (Fig. 11).



## PREPARING TO WORK

Before beginning to work, with the versions without CDS, it is necessary to:

1. Make sure the recovery tank is empty, otherwise empty it completely (read "[EMPTYING THE RECOVERY TANK](#)").
2. Verify that the quantity of detergent solution in the solution tank is suitable for the type of work you wish to carry out, otherwise fill the solution tank (see the paragraph "[FILLING THE SOLUTION TANK WITH WATER](#)"). View the level tube (1) in the rear of the machine (Fig. 1).
3. Make sure that the squeegee rubber blades are in good working condition. If not, carry out maintenance (see "[CLEANING THE SQUEEGEE BODY](#)").
4. Check the brush is in good working condition. If it isn't, replace it (see "INSTALLING THE BRUSH").
5. For B versions, make sure the device is switched off. If it isn't, press the main switch (2) on the back of the device (Fig. 2).

**i** **N.B.:** in B versions, the main switch (2) is in the idle position when the LED inside it is OFF and the activation symbol is not visible.

6. For the BT - BTS - BTO versions, make sure the device is switched off. If it isn't, set the main switch (3) to "0" by turning the key (4) a quarter turn to the left (Fig. 3). Remove the key from the instrument panel.

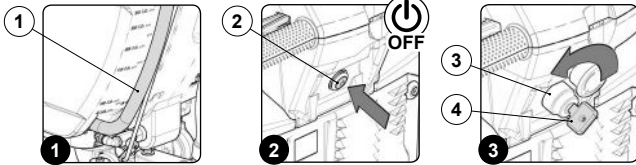

7. Grip the handle (5) on the left side of the recovery tank (Fig. 4) and turn the tank as far as it will go, until it reaches the maintenance position (Fig. 5).
8. Connect the battery connector (7) to the main system connector (6) (Fig. 6).

**!** **WARNING:** This process must be carried out by qualified personnel.

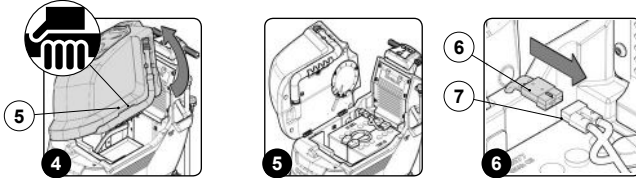

9. Grip the handle (5) on the left side of the recovery tank (Fig. 7).
10. Turn the recovery tank as far as it will go, to the work position (Fig. 8).
11. For the BT - BTS - BTO versions, make sure the electronic brake is engaged. If it isn't, turn the lever (8) in the direction indicated by the arrow. The traction gearmotor is located on the left side of the device (Fig. 9).

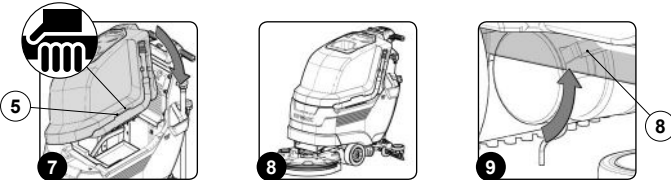

12. Make sure the water tap is fully open; the water adjustment knob (9) should be completely down (Fig. 10).
13. Check that the solution tank discharge cap (10) is closed. If it isn't, open it (Fig. 11).

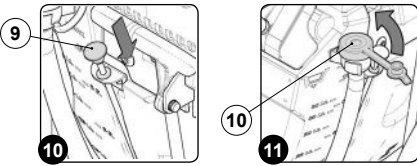

Before beginning to work, with the versions with the CDS system, it is necessary to:

1. Make sure the recovery tank is empty, otherwise empty it completely (read "[EMPTYING THE RECOVERY TANK](#)").
2. Verify that the amount of water present in the solution tank is sufficient for the type of work you wish to carry out, otherwise fill the solution tank (see the paragraph titled "[FILLING THE SOLUTION TANK WITH WATER](#)"). View the level tube (1) in the rear of the machine (Fig. 1).
3. Make sure that the amount of detergent in the canister inside the solution tank is sufficient for the type of work you want to carry out, otherwise fill it up with detergent (read "[FILLING THE DETERGENT CANISTER \(versions with CDS\)](#)").
4. Make sure that the squeegee rubber blades are in good working condition. If not, carry out maintenance (see "[CLEANING THE SQUEEGEE BODY](#)").
5. Check the brush is in good working condition. If it isn't, replace it (see "INSTALLING THE BRUSH").
6. For BT versions, make sure the device is switched off. If it isn't, bring the main switch (2) to the "0" position by making a quarter turn to the left with the key (3) (Fig. 2). Remove the key from the instrument panel.

7. Grip the handle (4) on the left side of the recovery tank (Fig. 3) and turn the tank as far as it will go, until it reaches the maintenance position (Fig. 4).

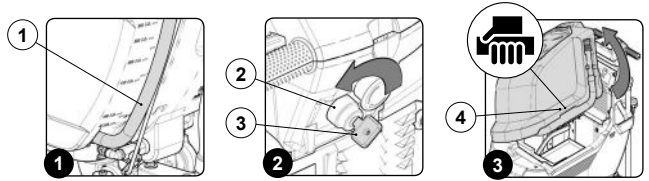

8. Connect the battery connector (6) to the main system connector (5) (Fig. 5).

**!** **WARNING:** This process must be carried out by qualified personnel.

9. Grip the handle (4) on the side of the recovery tank (Fig. 6).

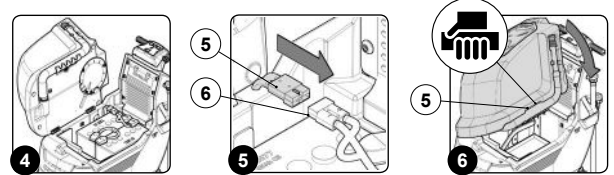

10. Turn the recovery tank as far as it will go, to the work position (Fig. 7).
11. For BT versions, make sure the electronic brake is engaged. If it isn't, turn the lever (7) in the direction of the arrow. The traction gearmotor is located on the left side of the device (Fig. 8).
12. Make sure the water tap is fully open: the water adjustment knob (8) should be completely down (Fig. 9).

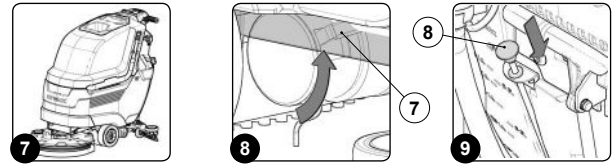

13. For the BT versions, bring the main switch (2) to its "I" position by turning the key (3) a quarter turn to the right (Fig. 10).
14. When the work screen appears on the control display, press the water flow adjustment button (9) (Fig. 11).

**i** **N.B.:** Set the amount of water present in the dosing system to maximum by pressing the button (10) until the "WATER LEVEL ADJUSTMENT" symbol is completely filled (Fig. 12).

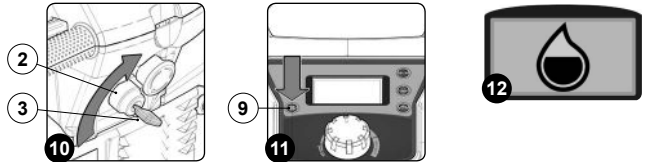

15. After adjusting the amount of water in the dosing circuit, press the button (10) for adjusting the detergent percentage supplied by the dosing system (Fig. 13).

**i** **NOTE:** Set the percentage of detergent present in the dosing system to the maximum value by pressing the button (10) until the "DETERGENT PERCENTAGE ADJUSTMENT" symbol is completely filled (Fig. 14).

16. Check that the potentiometer knob (11) is set to minimum, otherwise turn it completely counter-clockwise (Fig. 15).

**i** **N.B.:** the device will not start to move (either forward or backward) if the potentiometer adjustment knob (11) is set to minimum.



17. Lower the brush head unit by pressing the brush head control pedal (12) on the back of the appliance (Fig. 16).
18. Lower the squeegee unit using the lever (13) on the back of the appliance (Fig. 17).
19. When the dead man's lever (14) is activated (Fig. 18), the brush head gearmotor and the vacuum motor will enter into function. At the same time, the solenoid valve and dosing system will begin supplying the detergent solution to the brush.
20. Wait a few moments, keeping the accelerator pedal gently depressed (normally 40 - 60 seconds) to allow the system to engage.



## WORK

### STARTING WORK (B versions)

To start working, do as follows:

1. Make all the checks listed in "PREPARING TO WORK".
2. Get in the driving seat, behind the machine.
3. Press the main system control button (1) so it is in the "work" position (Fig. 1).

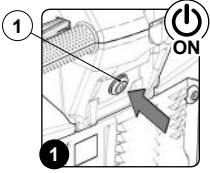

**i** N.B.: when the main system control button is functioning, the LED inside it is activated.

### SCRUBBING AND DRYING (B versions)

To carry out "SCRUBBING AND DRYING" tasks, proceed as follows:

1. Carry out all the checks indicated in the section "STARTING WORK (B versions)".
2. Lower the brush head unit by pressing the brush head control pedal (1) on the back of the appliance (Fig. 1).
3. Activate the brush head gearmotor using the brush control switch (2) (Fig. 2).
4. Lower the squeegee unit by means of the lever (3) on the back of the appliance (Fig. 3).

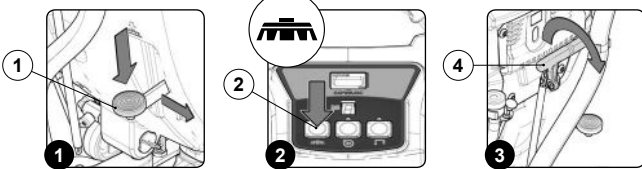

5. By activating the dead man's lever (4), the machine will start to move (Fig. 4).
6. Activate the vacuum motor by pressing the relative switch (5) on the control panel (Fig. 5).
7. Activate the motor of detergent solution by pressing the switch (6) on the control panel (Fig. 6).

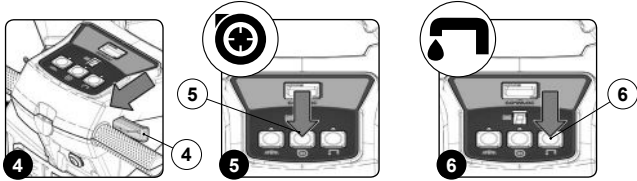

8. Check the detergent solution tap is fully open. If it isn't, turn the lever (7) on the back of the appliance (Fig. 7).
9. During the first few metres, check that the detergent solution is suitable for the work to be carried out. If it isn't, make the necessary changes after reading the paragraph "ADJUSTING THE DETERGENT SOLUTION (versions without CDS system)".

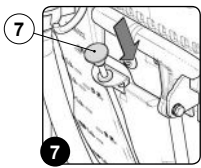

The appliance will now begin to work with full efficiency until the battery is flat or until the detergent solution has finished. During the first few metres, check that there is sufficient solution and that the squeegee is drying correctly.

- i** N.B.: if during the scrubbing - drying operation the dead man's lever is released, the brush motor and the solenoid valve will stop working, the vacuum motor will continue to work for a few seconds to ensure all the liquid in the vacuum hose is sucked up.
- i** N.B.: when filling the solution tank, it is good practice to empty the recovery tank using the special drainage hose.
- i** N.B.: by pulling the detergent solution flow adjustment knob downwards, the amount of solution in the water system will increase (Fig. 7).

### SCRUBBING WITHOUT DRYING (B versions)

To carry out "SCRUBBING WITHOUT DRYING" tasks, proceed as follows:

1. Carry out all the checks indicated in the section "STARTING WORK (B versions)".
2. Lower the brush head unit by pressing the brush head control pedal (1) on the back of the appliance (Fig. 1).
3. Activate the brush head gearmotor using the brush control switch (2) (Fig. 2).
4. By activating the dead man's lever (3), the machine will start to move (Fig. 3).

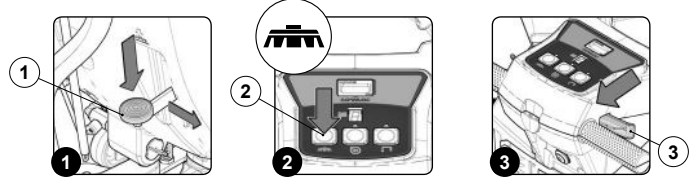

5. Activate the supply of detergent solution by pressing the switch (4) on the control panel (Fig. 4).
6. Check the detergent solution tap is fully open. If it isn't, turn the lever (5) on the back of the appliance (Fig. 5).
7. During the first few metres, check that the detergent solution is suitable for the work to be carried out. If it isn't, make the necessary changes after reading the paragraph "ADJUSTING THE DETERGENT SOLUTION (versions with CDS system)".

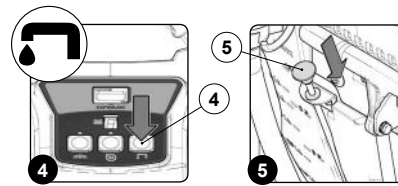

The appliance will now begin to work with full efficiency until the battery is flat or until the detergent solution has finished. During the first few metres, check that there is sufficient solution.

- i** N.B.: if the dead man's lever is released during the scrubbing and drying operation, the brush motor and solenoid valve will stop working. To resume work, just press the dead man's levers.
- i** N.B.: by pulling the detergent solution flow adjustment knob downwards, the amount of solution in the water system will increase (Fig. 5).

### DRYING (B versions)

To carry out "DRYING" tasks, proceed as follows:

1. Carry out all the checks indicated in the section "STARTING WORK (B versions)".
2. Lower the squeegee unit by means of the lever (1) on the back of the appliance (Fig. 1).
3. By activating the dead man's lever (2), the machine will start to move (Fig. 2).
4. Activate the vacuum motor by pressing the relevant switch (3) on the control panel (Fig. 3).

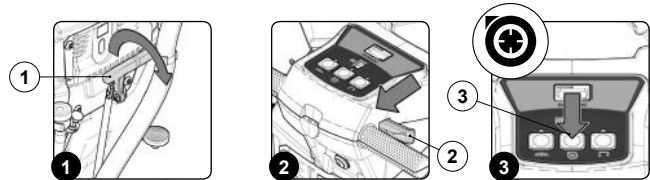

**! The drying without scrubbing operation should only be carried out if beforehand the device was used to carry out scrubbing without drying.**

The machine will now work at its maximum efficiency level until the batteries run down.

- i** N.B.: if the dead man's lever is released during the drying operation, the vacuum motor will continue working for another few seconds so that all the liquid in the vacuum hose can be removed.

### STARTING THE WORK ACTIVITIES (BT - BTS - BTO VERSIONS)

To start working, do as follows:

1. Make all the checks listed in ["PREPARING TO WORK"](#).
2. Get in the driving seat, behind the machine.
3. Bring the main switch (1) to "I", making a quarter turn to the right with the key (2) (Fig. 1).
4. When the display comes on, three screens appear in sequence.

- The first screen displayed indicates the name of the machine.
- The second screen shows the machine programming characteristics.
- The third screen displays the work panel (Fig. 2).

**(i)** *N.B.:* The symbol in the top right indicates the charge level of the batteries.

5. Check that the potentiometer knob (3) is set to minimum. If it isn't, turn it completely counter-clockwise (Fig. 3).

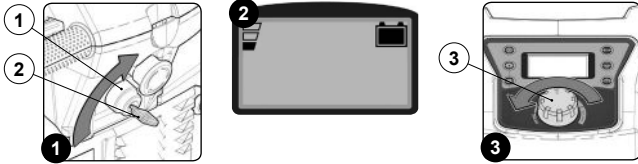

### SCRUBBING AND DRYING (BT - BTS - BTO VERSIONS)

To carry out "SCRUBBING AND DRYING" tasks, proceed as follows:

1. Carry out all the checks indicated in the section ["STARTING WORK \(BT - BTS - BTO versions\)"](#).
2. For versions BT - BTS - BTO, lower the brush head body by pressing the brush head control pedal (1) on the back of the appliance (Fig. 1).
3. For the PM versions, lower the brush head body, press the "BRUSH HEAD COMMAND" button (2) on the control panel (Fig. 2).

**(i)** *N.B.:* As soon as the brush head body is removed from the rest position the control display shows the symbol (3) (Fig. 3).

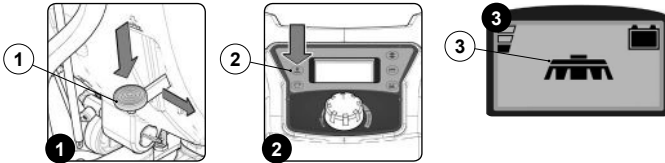

4. Lower the squeegee body using the lever (4) on the back of the appliance (Fig. 4).

**(i)** *N.B.:* As soon as the squeegee body is removed from the rest position the control display shows the symbol (5) (Fig. 5).

**(i)** *N.B.:* When both symbols (3) and (5) appear in the control display it means that "SCRUBBING WITH DRYING" is being carried out (Fig. 5).

5. Pull the knob (6) down and adjust the amount of solution desired (Fig. 6).

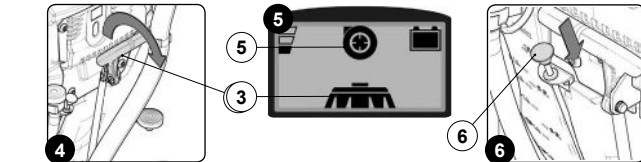

**(i)** *N.B.:* by pulling the detergent solution flow adjustment knob downwards, the amount of solution in the water system will increase (Fig. 6).

6. Use the dead man's levers (7) on the instrument panel (Fig. 7).

**(i)** *N.B.:* The appliance has two forward speeds. By pushing the dead man's levers beyond the first CLICK the "SLOW" speed is activated, continuing to push the levers beyond the second CLICK the "FAST" speed is activated.

7. Set the required forward speed by turning the knob (8) gradually to the right (Fig. 8).

**(i)** *N.B.:* For adjustments to the forward speed read the paragraph ["ADJUSTING THE FORWARD SPEED \(BT - BTS - BTO versions\)"](#).

As soon as the dead man's levers are pressed the traction motor, brush head motor and vacuum motor will start working. As a result, the solenoid valve will also begin working and detergent solution will be delivered to the brush.

During the first few metres, check that there is sufficient solution and that the squeegee is drying correctly. The appliance will now begin to work with full efficiency until the battery is flat or until the detergent solution has finished.

**(i)** *N.B.:* If the dead man's levers are released during the work the appliance will stop moving forward, the brush motor and the solenoid valve will stop working, while the vacuum motor will keep working for a set period of time (factory setting is fifteen seconds) and the symbol (4) will start flashing until the vacuum motor switches off.

**(i)** *N.B.:* If the appliance had to be switched off with the brush head and the squeegee body still in contact with the floor, when switched on again the work display will show the symbols (3) and (5), indicating that when it was switched off it was carrying out scrubbing with drying (Fig. 5).

**(i)** *N.B.:* If, during work, there is the need to exert more pressure on the brushes (versions with PM) simply press the "BRUSH HEAD COMMAND" button (2) on the control panel (Fig. 2) for more than three seconds, the command display shows the symbol (9) (Fig. 9).

**(i)** *N.B.:* If, during work, there is the need to return to working without exerting more pressure on the brushes (versions with PM) simply press the "BRUSH HEAD COMMAND" button (2) on the control panel (Fig. 2) for more than three seconds, the command display shows the symbol (3) (Fig. 5).

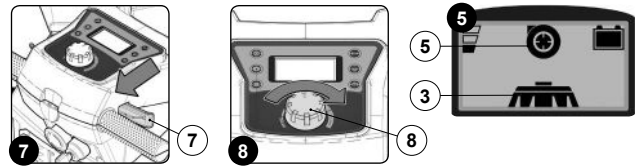

### SCRUBBING WITHOUT DRYING (BT - BTS - BTO VERSIONS)

To carry out "SCRUBBING WITHOUT DRYING" tasks, proceed as follows:

1. Carry out all the checks indicated in the section ["STARTING WORK \(BT - BTS - BTO versions\)"](#).
2. For versions BT - BTS - BTO, lower the brush head body by pressing the brush head control pedal (1) on the back of the appliance (Fig. 1).
3. For the PM versions, lower the brush head body, press the "BRUSH HEAD COMMAND" button (2) on the control panel (Fig. 2).

**(i)** *N.B.:* As soon as the brush head body is removed from the rest position the control display shows the symbol (3) (Fig. 3).

**(i)** *N.B.:* When the symbol (3) is shown on the control display it means that the work being carried out is "SCRUBBING WITHOUT DRYING" (Fig. 3).

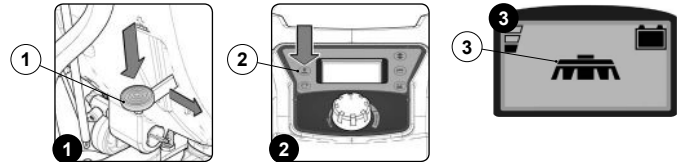

4. Pull the knob (4) down and adjust the amount of solution desired (Fig. 4).

**(i)** *N.B.:* by pulling the detergent solution flow adjustment knob downwards, the amount of solution in the water system will increase (Fig. 4).

5. Use the dead man's levers (5) on the instrument panel (Fig. 5).

**(i)** *N.B.:* The appliance has two forward speeds. By pushing the dead man's levers beyond the first CLICK the "SLOW" speed is activated, continuing to push the levers beyond the second CLICK the "FAST" speed is activated.

7. Set the required forward speed by turning the knob (6) gradually to the right (Fig. 6).



**(i)** *N.B.:* For adjustments to the forward speed read the paragraph ["ADJUSTING THE FORWARD SPEED \(BT - BTS - BTO versions\)"](#).

As soon as the dead man's levers are pressed the traction motor, brush head motor and vacuum motor will start working. As a result, the solenoid valve will also begin working and detergent solution will be delivered to the brush.

During the first few metres, check that there is sufficient for the work that needs to be done. The appliance will now begin to work with full efficiency until the battery is flat or until the detergent solution has finished.

**(i)** *N.B.:* If the dead man's levers are released during the work the appliance will stop moving forward, the brush motor and the solenoid valve will stop working.

**(i)** *N.B.:* If the appliance had to be switched off with the brush head still in contact with the floor, when switched on again the work display will show the symbol (3), indicating that when it was switched off it was carrying out scrubbing (Fig. 3).

**(i)** *N.B.:* If, during work, there is the need to exert more pressure on the brushes (versions with PM) simply press the "BRUSH HEAD COMMAND" button (2) on the control panel (Fig. 2) for more than three seconds, the command display shows the symbol (7) (Fig. 7).

**(i)** *N.B.:* If, during work, there is the need to return to working without exerting more pressure on the brushes (versions with PM) simply press the "BRUSH HEAD COMMAND" button (2) on the control panel (Fig. 2) for more than three seconds, the command display shows the symbol (3) (Fig. 3).

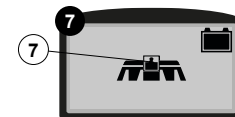



### DRYING WITHOUT SCRUBBING (BT - BTS - BTO VERSIONS)

To carry out "DRYING WITHOUT SCRUBBING" tasks, proceed as follows:

1. Carry out all the checks indicated in the section "[STARTING WORK \(BT - BTS - BTO versions\)](#)".
2. Lower the squeegee unit by means of the lever (1) on the back of the appliance (Fig. 1).

**i** **N.B.:** As soon as the squeegee unit is removed from the rest position the control display shows the symbol (2) (Fig. 2).

**i** **N.B.:** When the symbol (2) is shown on the control display it means that the work being carried out is "DRYING WITHOUT SCRUBBING" (Fig. 2).

3. Use the dead man's levers (3) on the instrument panel (Fig. 3).

**i** **N.B.:** The appliance has two forward speeds. By pushing the dead man's levers beyond the first CLICK the "SLOW" speed is activated, continuing to push the levers beyond the second CLICK the "FAST" speed is activated.

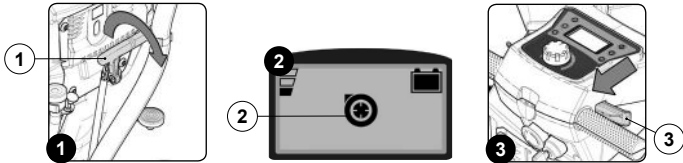

7. Set the required forward speed by turning the knob (4) gradually to the right (Fig. 4).

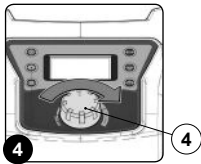

**i** **N.B.:** For adjustments to the forward speed read the paragraph "[ADJUSTING THE FORWARD SPEED \(BT - BTS - BTO versions\)](#)".

As soon as the dead man's levers are pushed the traction motor will start operating. During the first few metres of work, check that the squeegee is drying properly. The machine will now work at its maximum efficiency level until the batteries run down.

**i** **N.B.:** If the dead man's levers are released during the work the appliance will stop moving forward, the vacuum motor will keep working for a set period of time (factory setting is fifteen seconds) and the symbol (2) will start flashing until the vacuum motor switches off.

**i** **N.B.:** If the appliance has to be switched off with the brush head still in contact with the floor, when switched on the work display will show the symbol (2), indicating that when it was switched out drying without scrubbing (Fig. 2).



**The drying without scrubbing operation should only be carried out if beforehand the device was used to carry out scrubbing without drying.**

### ADJUSTING THE DETERGENT SOLUTION (versions without CDS system)

To adjust the amount of detergent solution on the brush, proceed as follows:

1. Fully open the flow from the tap on the back of the appliance by pulling the knob (1) on the back of the appliance downwards (Fig. 1).
2. By pushing the dead man's lever (2) the brush motor will start operating and the solenoid valve will distribute detergent solution to the brush (Fig. 2).

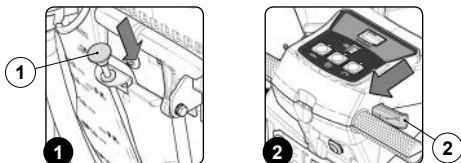

3. During the first few meters, check that the quantity of solution is enough to wet the floor, but not so much as to come out of the splash guard; the detergent disposal quantity can be adjusted by means of the knob (1) on the appliance's rear.

### ADJUSTING THE DETERGENT SOLUTION (versions with CDS system)

To regulate the amount of detergent solution on the brushes, proceed as follows:

1. Fully open the flow from the tap on the back of the appliance by pulling the knob (1) on the back of the appliance downwards (Fig. 1).

**i** **N.B.:** before regulating the solution, check there is detergent in the inner canister, and that the water tap on the side is open.

2. By pressing the water level adjustment button (2) once (Fig. 2), you can see the level of water in the appliance water system.

3. As soon as the water level adjustment button (2) is pressed, the "WATER LEVEL ADJUSTMENT" symbol will appear in the middle of the screen, highlighting the level (Fig. 3).

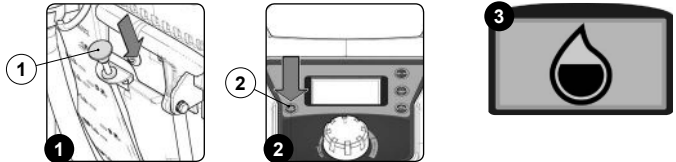

4. By pressing the button (2) for adjusting the amount of water in the water circuit once again, you can alter the level (Fig. 2).

**i** **N.B.:** the water status is temporarily shown on the display. When the button is pressed, the current level will be shown.

**i** **N.B.:** keep the button pressed for more than 2 seconds to reset the flow (Fig. 4).

**i** **N.B.:** each time the button is pressed, the level increases. When the maximum level is reached, the setting returns to zero.

**i** **N.B.:** the water level refers to the flow delivered at maximum machine speed. At intermediate speeds, the flow is reduced and is proportional to the value set.

**i** **N.B.:** there are eight levels that can be set (including "DELIVERY OFF" (Fig. 4)).

**i** **N.B.:** the right water flow should be proportional to the degree of dirt on the floor.

5. By pressing the detergent percentage adjustment button (3) once (Fig. 5), you can see the level of water in the appliance water system.

6. As soon as the water level adjustment button (3) is pressed, the "WATER LEVEL ADJUSTMENT" symbol will appear in the middle of the screen, highlighting the level (Fig. 6).

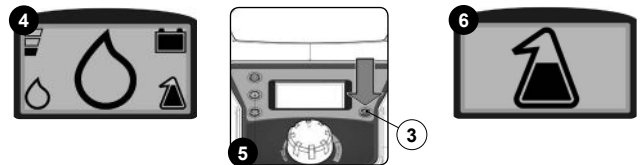

7. By pressing the button (3) for adjusting the amount of water in the water circuit once again, you can alter the level (Fig. 5).

**i** **N.B.:** the water status is temporarily shown on the display. When the button is pressed, the current level will be shown.

**i** **N.B.:** keep the button pressed for more than 2 seconds to reset the flow (Fig. 7).

**i** **N.B.:** each time the button is pressed, the level increases. When the maximum level is reached, the setting returns to zero.

**i** **N.B.:** the water level refers to the flow delivered at maximum machine speed. At intermediate speeds, the flow is reduced and is proportional to the value set.

**i** **N.B.:** there are eight levels that can be set (including "DELIVERY OFF" (Fig. 7)).

**i** **N.B.:** the right water flow should be proportional to the degree of dirt on the floor.

8. By pressing the dead man's levers (4), both the brush motor and the vacuum motor will start working and the solenoid valve will deliver detergent solution to the brush (Fig. 8).



9. During the first few meters check that the amount of solution is sufficient to wet the floor, but not excessive to exit the splash guard.



**ATTENTION:** to resolve any malfunctioning of the CDS system, contact the Assistance Centre.

### FORWARD SPEED REGULATION (B versions)

The traction of this appliance is obtained by means of the brush which, working with the right weight distribution, is able to pull the appliance forwards. To regulate the forward speed, proceed as follows:

- Adjust the forward speed by turning the knob (1) on the front of the appliance (Fig. 1).
  - N.B.:** turning the knob (1) clockwise tilts the brush forward, thus increasing the friction with the floor and thereby increasing the speed of the appliance.
  - N.B.:** turning the knob (1) counter-clockwise tilts the brush backward, thus decreasing the friction with the floor and thereby decreasing the speed of the appliance.
- Get in the driving seat, behind the machine.
- Press the main system control button (2) so it is in the "work" position (Fig. 2).
  - N.B.:** when the main system control button is functioning, the LED inside it is activated.
- Press the dead man's levers (3), positioned under the control handlebar (Fig. 3).

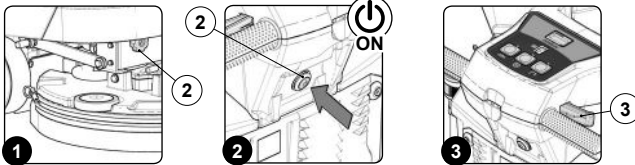

- Check that the adjustment carried out is as required, otherwise adjust the knob again (1).

### ADJUSTING THE FORWARD MOVEMENT SPEED (BT - BTS - BTO VERSIONS)

This machine is equipped with electronically controlled traction. To regulate the potentiometer, proceed as follows:

- Check that the knob (1) is set to minimum, if not, turn it counter-clockwise (Fig. 1).
- Turn the main machine switch (2) to "I", turning the key a quarter turn to the right (Fig. 2).
- Press the dead man's levers (3), positioned under the control handlebar (Fig. 3).

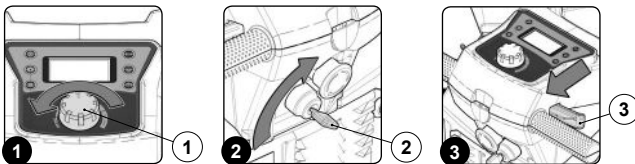

- Adjust the forward speed by gradually turning the knob (1) clockwise (Fig. 4).

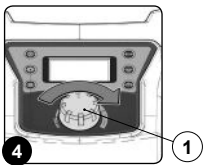

- N.B.:** the device will not start to move (either forward or backward) if the potentiometer adjustment knob (1) is set to minimum.
- N.B.:** Forward speed can be increased by turning the potentiometer's knob (1) clockwise.
- N.B.:** The appliance has two forward speeds. By pushing the dead man's levers beyond the first CLICK the "SLOW" speed is activated, continuing to push the levers beyond the second CLICK the "FAST" speed is activated.
- N.B.:** Adjusting a speed, slow or fast, will imply the automatic modification of the other.

### REVERSE MOVEMENT (BT - BTS - BTO VERSIONS)

This machine is equipped with electronically controlled traction. To reverse, proceed as follows:

- Check that the knob (1) is set to minimum, if not, turn it counter-clockwise (Fig. 1).
- Check that the brush head unit is raised off the floor, pressing the pedal (2) on the back of the device if necessary (Fig. 2).
- Check that the squeegee unit is raised off the floor, adjusting the lever (3) on the back of the device if necessary (Fig. 3).



- Turn the main machine switch to "I", making a quarter turn to the right with the key (4) (Fig. 4).
- Press the "REVERSE MOVEMENT ACTIVATION - DEACTIVATION" button (5) on the control panel (Fig. 5).
- Engage the dead man's levers (6) on the handlebar (Fig. 6) to start moving the appliance in reverse mode.

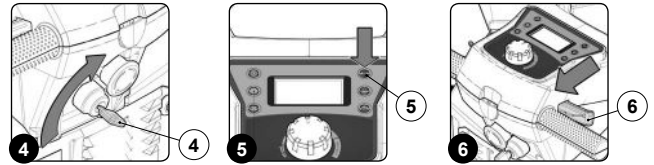

- N.B.:** as soon as you press the button (5) on the control panel (Fig. 5), the control display will show the "REVERSE" screen (Fig. 7).

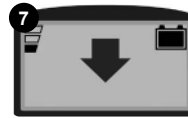

- N.B.:** the reverse speed is lower than the forward speed to comply with current health and safety standards. If the potentiometer is adjusted while reversing, the adjustment of the forward speed will be automatically changed.
- N.B.:** it is impossible to reverse if the squeegee unit touches the floor. In order to reverse, lift the squeegee unit from the floor using the relevant lever on the back of the appliance.
- N.B.:** to disable reverse movement, press the button (5) on the control panel again (Fig. 5).
- N.B.:** as soon as the button (5) is pressed, the acoustic signal advising that reverse function has been activated will sound.

### EMERGENCY SWITCH (BT - BTS - BTO VERSIONS)

This device has an emergency switch, to activate it just press the button (1) on the rear of the device.

- N.B.:** This command interrupts the electrical circuit between the batteries and the machine system.
- N.B.:** After stopping and resolving the problem, turn the key to "0", set the button (1) to the standard position and turn the key to "I" to resume the work.
- N.B.:** As soon as the emergency button is pressed, the control display show the symbol (2) (Fig. 2) it will continue flashing until the switch is brought back to its standard position.

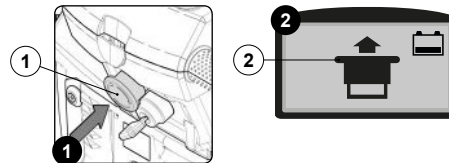

### ECO-MODE FUNCTION (versions BT - BTS - BTO)

This appliance has an eco-mode function, which reduces the energy absorption. To activate or deactivate the eco-mode function just press the button (1) on the instrument panel (Fig. 1). When the eco-mode is active, the symbols for the working programs will change, only the contours will remain visible, like the example in Fig. 2 where scrubbing in eco-mode symbol is shown.

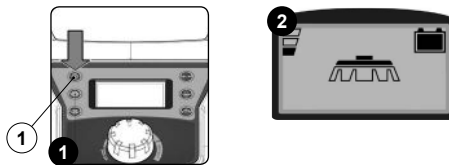

### ALARM SCREEN (BT - BTS - BTO versions)

If an error occurs, the control display will show the screen for the error, and it will remain visible until the error is resolved.

When an error occurs, do as follows:

- Stop the machine.
- Switch off the machine, set the main switch (1) to "0" by turning the key (2) a quarter turn anti-clockwise (Fig. 1).
- Contact the nearest service centre to explain the issue the machine is having referring the code (3) and the alarm designation (4) will be shown on the display (Fig. 2).

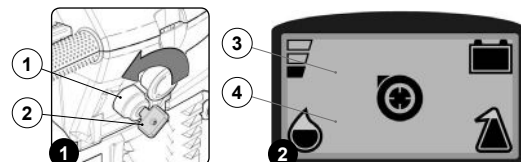

### OVERFLOW DEVICE (B versions)

The appliance is equipped with a mechanical device (float) under the recovery tank cap that, when the recovery tank is full, shuts off the air to the vacuum motor intake to protect it; the sound of the vacuum motor will then be deeper.

1. Deactivate the supply of detergent solution by pressing the solenoid valve command switch (1) on the control panel (Fig. 1).
2. Deactivate the brush head gearmotor by pressing the brush head gearmotor command switch (2) on the control panel (Fig. 2).
3. Raise the brush head unit off the floor by pressing the pedal (3) on the back of the appliance (Fig. 3).

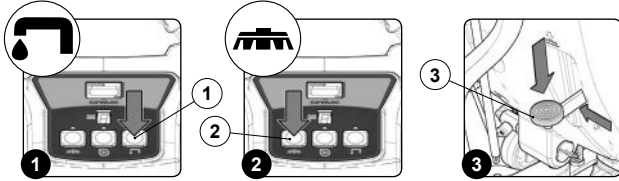

4. Deactivate the vacuum motor by pressing the vacuum motor command switch (4) on the control panel (Fig. 4).
5. Raise the squeegee unit off the floor by means of the lever (5) on the back of the appliance (Fig. 5).
6. Switch off the appliance by pressing the main switch (6) on the back of it (Fig. 6).

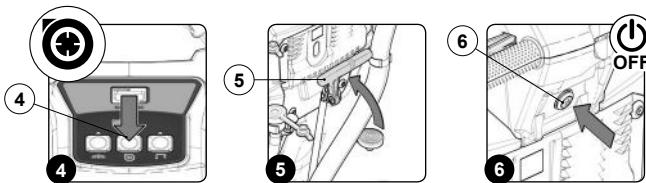

**i** N.B.: the main switch (6) is in the idle position when the LED inside it is OFF and the activation symbol is not visible.

7. Take the appliance to the designated waste water drainage area and empty the recovery tank (read the paragraph "EMPTYING THE RECOVERY TANK" and "CLEANING THE RECOVERY TANK FLOAT-FILTER").

### VACUUM WAND KIT (versions with SST system)

Upon request, the machine can be fitted with the VACUUM WAND system, a system that vacuums up the detergent solution more accurately. To start it do as follows.

1. Start the appliance, turn the main switch (1) to "I", making a quarter turn to the right with the key (2) (Fig. 1).
2. Make sure that the brush head body is raised to the rest position, if it is not press the "BRUSH HEAD CONTROL" button (3) on the control panel (Fig. 2).
3. Make sure that the squeegee body is raised to the rest position, if it is not turn the squeegee control lever (4) in the direction of the arrow in (Fig. 3). The lever is located on the back of the device.

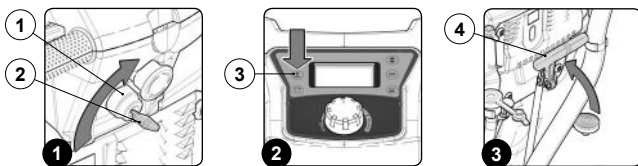

4. Remove the vacuum wand kit from the side support (Fig. 4).
5. Remove the vacuum tube (5) from the sleeve (6) in the squeegee body (Fig. 5).
6. Connect the telescopic tube (7) in the vacuum wand kit with the vacuum tube (5) (Fig. 6).



7. Activate the vacuum control kit, press the button (8) on the control panel (Fig. 7).

**i** N.B.: as soon as the button (8) on the control display is pressed, the symbol (9) will appear (Fig. 8).

**!** **ATTENTION:** never pick up solid matter such as dust, cigarette stubs, paper, etc.

**!** **ATTENTION:** Never collect gases, explosive/inflammable liquids or powders, nor acids and solvents! These include gasoline, paint thinners and fuel oil (which, when mixed with the vacuum air, can form explosive vapours or mixtures), and also non-diluted acids and solvents, acetones, aluminium and magnesium powders. These substances may also corrode the materials used to construct the machine.

**!** **WARNING:** If the machine is used in dangerous areas (e.g. petrol stations), the relative safety standards must be observed. It is forbidden to use the machine in environments with a potentially explosive atmosphere.

12. Once the work is finished, deactivate the vacuum control kit, press the button (8) on the control panel (Fig. 7).
13. Disconnect the telescopic tube (7) from the vacuum hose (5) (Fig. 6).
14. Connect the vacuum hose (5) to the sleeve (6) in the squeegee body (Fig. 9).
15. Put back the vacuum wand kit in the side support (Fig. 4).

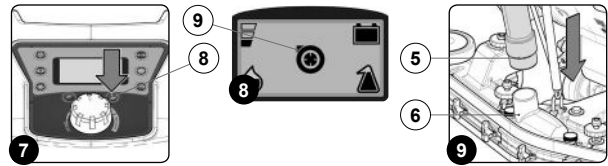

### OVERFLOW DEVICE

The appliance is equipped with a mechanical device (float) under the recovery tank cap that, when the recovery tank is full, shuts off the air to the vacuum motor intake to protect it; the sound of the vacuum motor will then be deeper.

For versions without PM proceed as follows:

1. Raise the brush head unit off the floor by pressing the pedal (1) on the back of the appliance (Fig. 1).
2. Raise the squeegee unit off the floor by means of the lever (2) on the back of the appliance (Fig. 2).

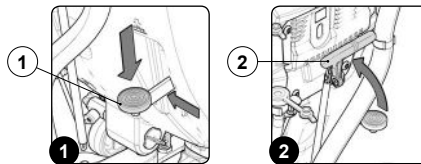

3. Take the appliance to the designated waste water drainage area and empty the recovery tank (read the paragraph "EMPTYING THE RECOVERY TANK" and "CLEANING THE RECOVERY TANK FLOAT-FILTER").

For versions with the PM system proceed as follows:

1. Start the appliance, turn the main switch (1) to "I", making a quarter turn to the right with the key (2) (Fig. 1).
2. Lift the brush head body and press the "BRUSH HEAD CONTROL" button (3) on the control panel (Fig. 2).
3. Raise the squeegee body and turn the squeegee control lever (4) in the direction of the arrow in (Fig. 3). The lever is located on the back of the device.

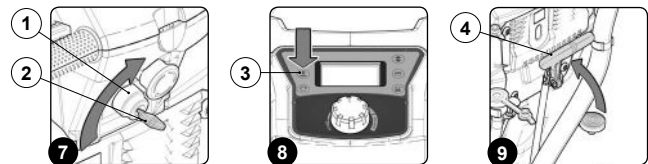

4. Take the appliance to the designated waste water drainage area and empty the recovery tank (read the paragraph "EMPTYING THE RECOVERY TANK" and "CLEANING THE RECOVERY TANK FLOAT-FILTER").

### AT THE END OF THE WORK

At the end of the work, and before carrying out any type of maintenance, perform the following operations:

1. Raise the brush head unit off the ground, for versions without the PM system use the pedal (1) on the back of the appliance (Fig. 1).
2. Raise the brush head body off the ground, for versions without the PM system press the "BRUSH HEAD CONTROL" button (2) on the control panel (Fig. 2).
3. Raise the squeegee body off the floor using the lever (3) on the back of the appliance (Fig. 3).

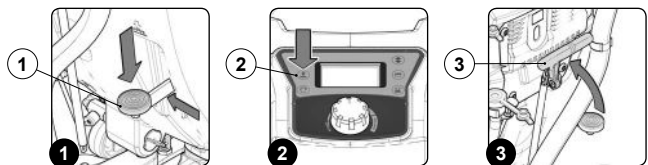

4. Take the appliance to the dedicated dirty water drainage area.
5. For the B versions, switch off the appliance by pressing the main switch (4) on the back of the appliance (Fig. 4).

**i** N.B.: the main switch (4) is in the idle position when the LED inside it is OFF and the activation symbol is not visible.

- For the BT - BTS - BTO versions, switch off the appliance, set the main switch (5) to "0" by turning the key (6) a quarter turn to the left (Fig. 5). Remove the key from the instrument panel.

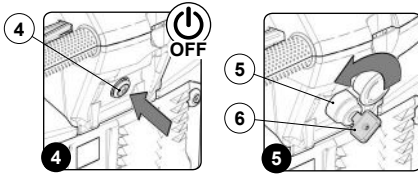

- Carry out all the procedures listed in the paragraph "RECOMMENDED PERIODIC MAINTENANCE" indicated in the column "AT THE END OF THE WORK".
- Take the appliance to the designated machine storage place.

**!** *N.B.:* Park the appliance in an enclosed place, on a flat surface; near the appliance there must be no objects that could either damage it, or be damaged through contact with it.

- Take all the necessary steps to ensure that the device is in a safe condition (see "MACHINE SAFETY").

**!** *N.B.:* if the appliance is not used for more than a day, remove the brush from the brush head body, read the paragraphs "CLEANING THE BRUSH", the squeegee body from the squeegee support read the paragraphs "CLEANING THE SQUEEGEE BODY".

## MAINTENANCE

### RECOMMENDED MAINTENANCE OPERATIONS

Type of maintenance	At the end of the work	Daily	Weekly	Prior to any long periods of time when not used, do the following	Transport
<a href="#">DRAINING THE RECOVERY TANK</a>	X	X		X	X
<a href="#">EMPTYING THE DEBRIS HOPPER (50BTS versions)</a>	X	X		X	X
<a href="#">EMPTYING THE DEBRIS HOPPER (65BTS versions)</a>	X	X		X	X
<a href="#">CLEANING THE SQUEEGEE BODY</a>	X	X		X	
<a href="#">CLEANING THE RECOVERY TANK FILTER-FLOAT</a>	X	X		X	
<a href="#">CLEANING THE BRUSH (B single brush version)</a>		X		X	
<a href="#">CLEANING THE BRUSH (BT single brush version)</a>		X		X	
<a href="#">CLEANING THE BRUSH (BT single brush version with PM system)</a>		X		X	
<a href="#">CLEANING THE BRUSH (BT double brush versions)</a>		X		X	
<a href="#">CLEANING THE BRUSH (BT double brush versions with PM system)</a>		X		X	
<a href="#">CLEANING THE BRUSH (50BTS double brush versions)</a>		X		X	
<a href="#">CLEANING THE BRUSH (65BTS double brush versions)</a>		X		X	
<a href="#">CLEANING THE DEBRIS HOPPER (50BTS double brush versions)</a>		X		X	
<a href="#">CLEANING THE DEBRIS HOPPER (65BTS double brush versions)</a>		X		X	
<a href="#">CLEANING THE VACUUM TUBE</a>		X		X	
<a href="#">EMPTYING THE SOLUTION TANK</a>		X		X	X
<a href="#">CLEANING THE WATER SYSTEM FILTER</a>			X	X	
<a href="#">CLEANING THE WATER SYSTEM (B versions)</a>			X	X	X
<a href="#">CLEANING THE WATER SYSTEM (versions BT - BTS - BTO)</a>			X	X	X
<a href="#">CLEANING THE WATER SYSTEM (versions BT - BTS - BTO with PM)</a>			X	X	X
<a href="#">CLEANING THE WATER SYSTEM (versions BT - BTS - BTO with CDS system)</a>			X	X	X
<a href="#">CLEANING THE WATER SYSTEM (versions BT - BTS - BTO with PM and CDS system)</a>			X	X	X
<a href="#">CLEANING THE RECOVERY TANK</a>			X	X	
<a href="#">CLEANING THE SOLUTION TANK</a>			X	X	
<a href="#">CLEANING THE DETERGENT CANISTER (versions with CDS system)</a>				X	X

### EMPTYING THE RECOVERY TANK

Proceed as follows to empty the recovery tank:

- Take the device to the dedicated maintenance area.
- Take all necessary steps to ensure that the device is in a safe condition (see "MACHINE SAFETY").

**!** *CAUTION:* users are advised to always wear protective gloves, to avoid the risk of serious injury to hands.

- Remove the drainage hose of the recovery tank from the clamps; it is located at the rear of the machine (Fig. 1).
- Bend the end of the drainage tube, so as to create a choke and prevent the content from coming out (Fig. 2), put the tube on the discharge surface and gradually release the tube.

**!** *N.B.:* the place designated for this operation must comply with current environmental protection regulations.

- Grip the handle (1) on the back of the recovery tank cover and remove it (Fig. 3).



- With the recovery tank empty, rotate the recovery tank cover support (2). The optional support is positioned on the left side of the appliance (Fig. 4).
- Insert the clamp (3) of the recovery tank cover in the slot (4) on the recovery tank cover support (Fig. 5).

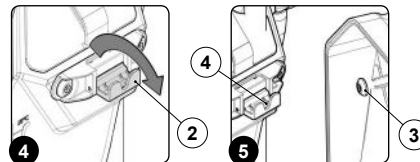

- Rinse the inside with a jet of water, if necessary use a spatula to remove the sludge that has accumulated at the bottom of the tank.
- Repeat the operations in reverse order to reassemble all the parts.

### EMPTYING THE DEBRIS HOPPER (50BTS double brush versions)

To empty the debris hopper, proceed as follows:

- Take the device to the dedicated maintenance area.

**!** *N.B.:* the place designated for this operation must comply with current environmental protection regulations.

- Take all necessary steps to ensure that the device is in a safe condition (see "MACHINE SAFETY").
- Raise the brush head unit off the floor and press the brush head control pedal (1) on the rear of the device (Fig. 1).

**!** *CAUTION:* these operations must be carried out using protective gloves to avoid any possible contact with the edges or tips of metal objects.

- Position yourself on the right-hand side of the appliance.
- Loosen the retainer knob (2) (Fig. 2).
- Remove the right side splash guard support (3), taking care to shift the blade before removing the splash guard support itself (Fig. 3).

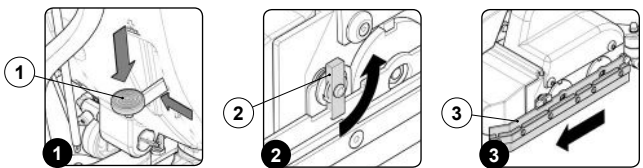

- Extract the debris hopper (4) from the brush head unit (Fig. 4).

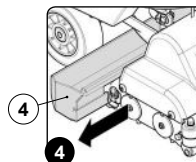

- Empty the inside of the debris hopper using a spatula to remove any dirt residues if necessary.
- Repeat the operations in reverse order to reassemble all the parts.

### EMPTYING THE DEBRIS HOPPER (65 BTS double brush versions)

To empty the debris hopper, proceed as follows:

1. Take the device to the dedicated maintenance area.
2. Take all necessary steps to ensure that the device is in a safe condition (see "MACHINE SAFETY").

**CAUTION:** these operations must be carried out using protective gloves to avoid any possible contact with the edges or tips of metal objects.

3. Stand on the left side of the appliance.
4. Remove the left side splash guard support (1) (Fig. 1).
5. Extract the debris hopper (2) from the brush head body (Fig. 2).

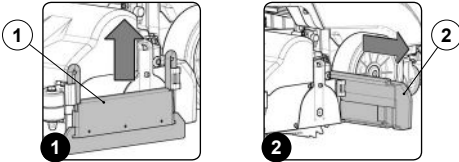

**N.B.:** To do this, use the moulded handle on the lower part of the debris hopper.

6. Empty the inside of the debris hopper using a spatula to remove any dirt residues if necessary.

**N.B.:** the place designated for this operation must comply with current environmental protection regulations.

7. Repeat the operations in reverse order to reassemble all the parts.

### CLEANING THE SQUEEGEE BODY

The careful cleaning of the whole vacuum unit ensures better drying and cleaning of the floor as well as a longer vacuum motor life. To carry out the cleaning of the squeegee body, proceed as follows:

1. Take the device to the dedicated maintenance area.
2. Take all necessary steps to ensure that the device is in a safe condition (see "MACHINE SAFETY").

**N.B.:** these operations must be carried out using protective gloves to avoid any possible contact with the edges or tips of metal objects.

3. Remove the vacuum hose (1) from the vacuum nozzle (2) on the squeegee body (Fig. 1).
4. Completely unscrew the knobs (3) on the squeegee body pre-assembly (Fig. 2).
5. Remove the squeegee body from the slits in the squeegee connector (Fig. 3).

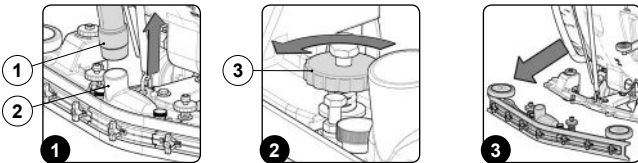

6. Thoroughly clean the squeegee body vacuum chamber (4) with a jet of water, and then with a damp cloth (Fig. 4).

**N.B.:** the place designated for this operation must comply with current environmental protection regulations.

7. Thoroughly clean the squeegee body front rubber blade (5) with a jet of water, and then with a damp cloth (Fig. 5).
8. Thoroughly clean the squeegee body's rear rubber blade (6) with a jet of water, and then with a damp cloth (Fig. 6).

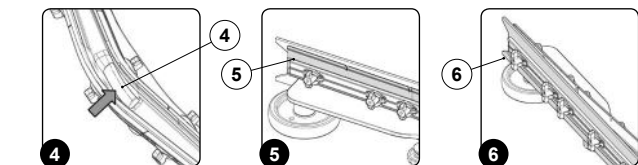

9. Unscrew the knobs (7) that fix the vacuum nozzle (3) to the squeegee body (Fig. 7).
10. Remove the vacuum nozzle (3) from the squeegee body (Fig. 7).
11. Thoroughly clean the vacuum nozzle (3) with a jet of water, and then with a damp cloth.
12. Also clean the support surface on the squeegee unit (Fig. 8).
13. Position the vacuum nozzle (3) on the squeegee unit and fix it in place by means of the knobs (8).
14. For refitting the squeegee unit read the paragraph "FITTING THE SQUEEGEE UNIT".

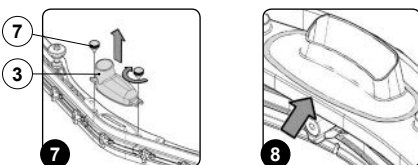

To clean the squeegee body with the spray gun, for versions with the SST system, proceed as follows:

1. Take the device to the dedicated maintenance area.
2. Lift the brush head body and press the "BRUSH HEAD CONTROL" button (1) on the control panel (Fig. 1).
3. Raise the squeegee unit and turn the squeegee control lever (2) in the direction of the arrow in (Fig. 2). The lever is located on the back of the device.

**CAUTION:** these operations must be carried out using protective gloves to avoid any possible contact with the edges or tips of metal objects.

4. Remove the vacuum hose (3) from the vacuum nozzle (4) on the squeegee body (Fig. 3).

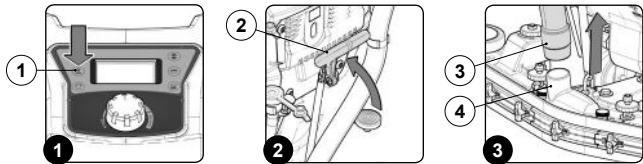

5. Completely unscrew the knobs (5) on the squeegee body pre-assembly (Fig. 4).
6. Remove the squeegee unit from the slits in the squeegee connector (Fig. 5).
7. Remove the spray gun kit from the storage compartment (Fig. 6).

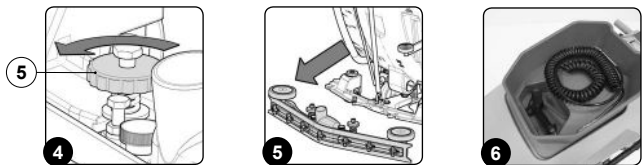

8. Connect the male quick-coupler (6) on the spiral hose (7) to the female quick-coupler (8) on the front of the appliance (Fig. 7).
9. Connect the male quick-coupler (9) on spray gun (10) to the female quick-coupler (11) on the spiral hose (7) (Fig. 8).
10. Activate the spray gun kit by pressing the button (12) on the steering column (Fig. 9).

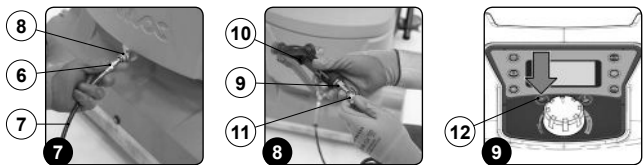

**CAUTION:** when using the optional tank cleaning kit, you are advised to always wear goggles to avoid any risk of serious injury to your eyes.

**N.B.:** before activating the optional tank cleaning kit, check the level indicator (13) to see how much solution there is in the solution tank (Fig. 10).

11. Start the delivery of detergent solution by pressing the lever (14) on the spray gun (Fig. 11).

**N.B.:** To adjust the solution jet coming out of the spray gun turn the knob (15) on the accessory itself (Fig. 12).



12. Thoroughly clean the vacuum chamber of the squeegee body, first with a jet of water and then with a damp cloth.

**N.B.:** the place designated for this operation must comply with current environmental protection regulations.

13. Thoroughly clean the vacuum chamber (16) of the squeegee body with a jet of detergent solution and then with a damp cloth (Fig. 13).
14. Thoroughly clean the front rubber blade (17) of the squeegee body with a jet of detergent solution and then with a damp cloth (Fig. 14).
15. Thoroughly clean the rear rubber blade (18) of the squeegee body with a jet of detergent solution and then with a damp cloth (Fig. 15).

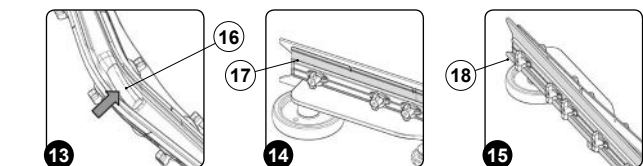

16. Unscrew the knobs (19) that fix the vacuum nozzle (20) to the squeegee body (Fig. 16).
17. Remove the vacuum nozzle (20) from the squeegee body (Fig. 16).
18. Thoroughly clean the vacuum nozzle (20) with a jet of detergent solution and then with a damp cloth.
19. Also clean the support surface on the squeegee unit (Fig. 17).
20. Place the vacuum nozzle (20) on the squeegee body and fix it in place using the knobs (19).

21. For refitting the squeegee unit read the paragraph **"FITTING THE SQUEEGEE UNIT"**.

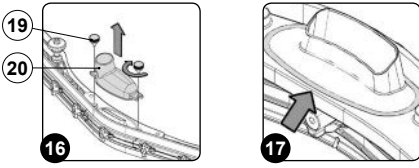

### CLEANING THE RECOVERY TANK FILTER-FLOAT

Careful cleaning of the recovery tank filter-float guarantees better cleaning of the floor as well as a longer vacuum motor lifespan. Proceed as follows to clean the recovery tank filter-float:

1. Take the device to the dedicated maintenance area.
2. Take all necessary steps to ensure that the device is in a safe condition (see **"MACHINE SAFETY"**).

**CAUTION:** users are advised to always wear protective gloves, to avoid the risk of serious injury to hands.

3. Grip the handle (1) on the back of the recovery tank cover and remove it (Fig. 1).
4. Rotate the recovery tank cover support (2). The optional support is positioned on the left side of the appliance (Fig. 2).
5. Insert the clamp (3) of the recovery tank cover in the slot (4) on the recovery tank cover support (Fig. 3).

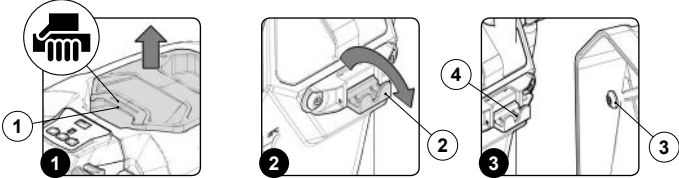

6. Remove the float cover (5), turning it in the direction of the arrow (Fig. 4).
7. Remove the vacuum filter (6) and clean it (Fig. 5).

**N.B.:** you are advised to use a jet of air to remove the impurities before cleaning the filter. Position the filter at least 20cm from the air jet.

**ATTENTION:** do not use highly corrosive products to clean the filter, to avoid damaging it.

8. Remove the upper part of the float (7), turning it in the direction of the arrow (Fig. 6).

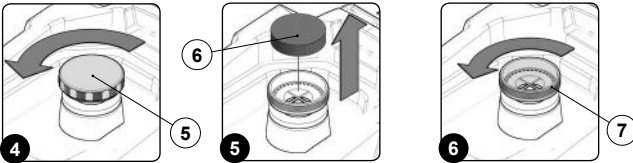

**N.B.:** when removing the upper part of the float, be very careful not to remove the lower part as well (8) (Fig. 7).

9. Remove the float (9) (Fig. 7). Rinse the inside with a jet of water. If necessary, use a spatula to remove the sludge that has accumulated at the bottom of the float.

**N.B.:** If the polyurethane ring on the float (Fig. 7) is damaged or excessively worn, contact your nearest service centre.

10. Repeat the operations in reverse order to reassemble all the parts.

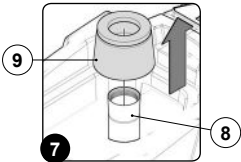

To clean the recovery tank filter-float with the spray gun, for versions with the SST system, proceed as follows:

1. Take the device to the dedicated maintenance area.
2. Lift the brush head body and press the "BRUSH HEAD CONTROL" button (1) on the control panel (Fig. 1).
3. Raise the squeegee unit and turn the squeegee control lever (2) in the direction of the arrow in (Fig. 2). The lever is located on the back of the device.
4. Remove the drainage hose of the recovery tank (3) from the clamps; it is located at the rear of the machine (Fig. 3).



5. Bend the end of the drainage tube, so as to create a choke and prevent the content from coming out (Fig. 4), put the tube on the discharge surface and gradually release the tube.

**N.B.:** the place designated for this operation must comply with current environmental protection regulations.

6. Grip the handle (4) on the back of the recovery tank cover and remove it (Fig. 5).
7. Rotate the recovery tank cover support (5). The optional support is positioned on the left side of the appliance (Fig. 6).

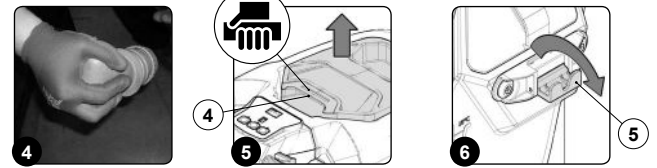

8. Insert the clamp (6) of the recovery tank cover in the slot (7) in the recovery tank cover support (Fig. 7).
9. Remove the spray gun kit from the storage compartment (Fig. 8).
10. Connect the male quick-coupler (8) on the spiral hose (9) to the female quick-coupler (10) on the front of the appliance (Fig. 9).

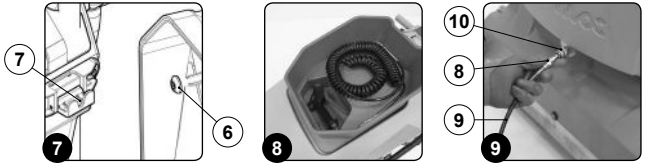

11. Connect the male quick-coupler (11) on spray gun (12) to the female quick-coupler (13) on the spiral hose (9) (Fig. 10).
12. Activate the spray gun kit by pressing the button (14) on the steering column (Fig. 11).

**CAUTION:** when using the optional tank cleaning kit, you are advised to always wear goggles to avoid any risk of serious injury to your eyes.

**N.B.:** Before activating the optional tank cleaning kit, check the level indicator (15) to see how much solution there is in the solution tank (Fig. 12).

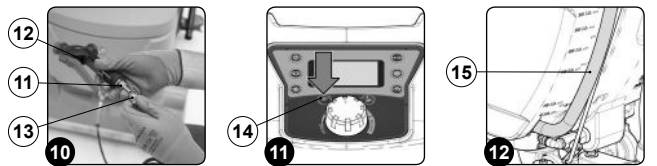

13. Start the delivery of detergent jet by pressing the lever (16) on the spray gun (Fig. 13).

**N.B.:** To adjust the solution jet coming out of the spray gun turn the knob (17) on the accessory itself (Fig. 14).

14. Remove the float cover (18), turning it in the direction of the arrow (Fig. 15).



15. Remove the vacuum filter (19) and clean it (Fig. 16).

**N.B.:** you are advised to use a jet of air to remove the impurities before cleaning the filter. Position the filter at least 20cm from the air jet.

**ATTENTION:** do not use highly corrosive products to clean the filter, to avoid damaging it.

16. Remove the upper part of the float (20), turning it in the direction of the arrow (Fig. 17).

**N.B.:** when removing the upper part of the float, be very careful not to remove the lower part as well (21) (Fig. 18).

17. Remove the float (22) (Fig. 18). Rinse inside with a jet of detergent solution. If necessary, use a spatula to remove any sludge that may have accumulated at the bottom of the float.

**N.B.:** If the polyurethane ring on the float body (Fig. 18) is excessively worn or damage contact the nearest service centre.

18. Repeat the operations in reverse order to reassemble all the parts.



### CLEANING THE BRUSH (B single brush version)

Careful cleaning of the brush guarantees better cleaning of the floor as well as a longer brush head gearmotor lifespan. To clean the brush, proceed as follows:

1. Take the device to the dedicated maintenance area.
  2. Raise the brush head unit off the floor and press the brush head control pedal (1) on the rear of the device (Fig. 1).
- i** **N.B.:** do not lift the brush head unit completely.
3. Deactivate the vacuum motor by pressing the vacuum motor command switch (2) on the control panel (Fig. 2).
  4. Press the dead man's levers (3) repeatedly three times (over the span of one minute) (Fig. 3).

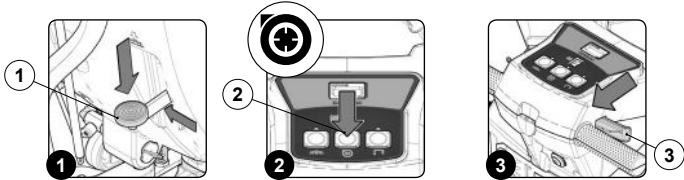

5. Clean the brush under running water to remove any impurities from its bristles. Check that the bristles are not worn; in the event of excessive wear, replace the brush (the bristles should be at least 10 mm long). Read the paragraph "FITTING THE BRUSH (B - BT single brush versions)" for replacing the brush.

**♻️ N.B.:** the place designated for this operation must comply with current environmental protection regulations.

6. Refit the splash guard, read the section "ASSEMBLING THE BRUSH HEAD SPLASH GUARD (ANTEA B - BT versions)".

### CLEANING THE BRUSH (BT single brush version)

Careful cleaning of the brush guarantees better cleaning of the floor as well as a longer brush head gearmotor lifespan. To clean the brush, proceed as follows:

1. Take the device to the dedicated maintenance area.
2. Raise the brush head unit off the floor and press the brush head control pedal (1) on the rear of the device (Fig. 1).

**i** **N.B.:** do not lift the brush head unit completely.

3. Press the "BRUSH UNCOUPLING" button (2) on the control panel (Fig. 2).

**i** **N.B.:** As soon as the "BRUSH UNCOUPLING" button (2) on the control panel is pressed (Fig. 2), the control display will show the "CONFIRM UNCOUPLING?" screen (Fig. 3).

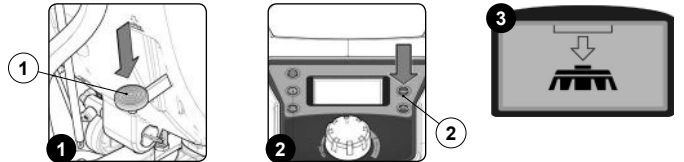

4. Press the "BRUSH UNCOUPLING" button (2) again to confirm.
5. Clean the brush under running water to remove any impurities from its bristles. Check that the bristles are not worn; in the event of excessive wear, replace the brush (the bristles should be at least 10 mm long). Read the paragraph "FITTING THE BRUSH (B - BT single brush versions)" for replacing the brush.
6. Refit the splash guard, read the section "ASSEMBLING THE BRUSH HEAD SPLASH GUARD (ANTEA B - BT versions)".

**⚠️ CAUTION:** these operations must be carried out using protective gloves to avoid any possible contact with the edges or tips of metal objects.

**⚠️ N.B.:** the place designated for this operation must comply with current environmental protection regulations.

### CLEANING THE BRUSH (BT single brush version with PM system)

Careful cleaning of the brush guarantees better cleaning of the floor as well as a longer brush head gearmotor lifespan. To clean the brush, proceed as follows:

1. Take the device to the dedicated maintenance area.
2. Lift the brush head body and press the "BRUSH HEAD CONTROL" button (1) on the control panel (Fig. 1).
3. Press the "BRUSH UNCOUPLING" button (2) on the control panel (Fig. 2).

**i** **N.B.:** As soon as the "BRUSH UNCOUPLING" button (2) on the control panel is pressed (Fig. 2), the control display will show the "CONFIRM UNCOUPLING?" screen (Fig. 3).

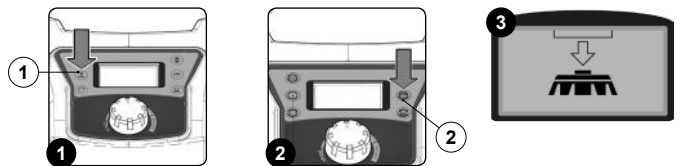

4. Press the "BRUSH UNCOUPLING" button (2) again to confirm.
5. Clean the brush under running water to remove any impurities from its bristles. Check that the bristles are not worn; in the event of excessive wear, replace the brush (the bristles should be at least 10 mm long). Read the paragraph "FITTING THE BRUSH (BT single brush versions)" for replacing the brush.

**⚠️ CAUTION:** these operations must be carried out using protective gloves to avoid any possible contact with the edges or tips of metal objects.

**♻️ N.B.:** the place designated for this operation must comply with current environmental protection regulations.

### CLEANING THE BRUSH (BT double brush versions)

Careful cleaning of the brush guarantees better cleaning of the floor as well as a longer brush head gearmotor lifespan. To clean the brush, proceed as follows:

1. Take the device to the dedicated maintenance area.
2. Take all necessary steps to ensure that the device is in a safe condition (see "MACHINE SAFETY").
3. Lower the brush head body off the floor and press the brush head control pedal (1) on the rear of the device (Fig. 1).
4. Position yourself at the front of the appliance.
5. Remove the splash guard carters (2), remove them (Fig. 2) and lay them gently on the ground.
6. Position yourself at the rear of the appliance.
7. Raise the brush head body off the floor and press the brush head control pedal (1) on the rear of the device (Fig. 3).

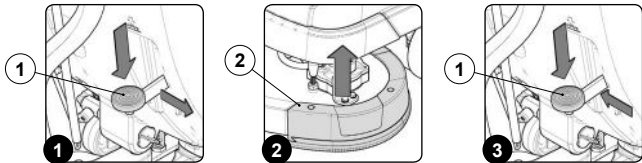

**⚠️ CAUTION:** these operations must be carried out using protective gloves to avoid any possible contact with the edges or tips of metal objects.

8. Position yourself at the front of the appliance.
9. Press the brush-holder plate latch (3) and simultaneously rotate the brush (4) according to the direction indicated in the image (Fig. 4).

**i** **N.B.:** The image Fig. 4 shows the rotation direction of the left brush.

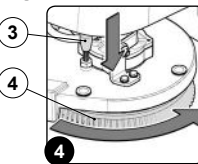

10. When brush rotation is prevented, turn until the button on the brush is disengaged from the coupling spring on the brush-holder plate.
11. Repeat the same operation for the right-hand brush.
12. Clean the brush under running water to remove any impurities from its bristles. Check that the bristles are not worn; in the event of excessive wear, replace the brush (the bristles should be at least 10 mm long). Read the paragraph "FITTING THE BRUSH (BT single brush versions)" for replacing the brush.

**♻️ N.B.:** the place designated for this operation must comply with current environmental protection regulations.

### CLEANING THE BRUSH (BT double brush versions with PM system)

Careful cleaning of the brush guarantees better cleaning of the floor as well as a longer brush head gearmotor lifespan. To clean the brush, proceed as follows:

1. Take the device to the dedicated maintenance area.
2. Check that the electronic brake is engaged, turn the lever (1) in the rear right part of the machine anti-clockwise (Fig. 1).
3. Start the appliance, turn the main switch (2) to "I", making a quarter turn to the right with the key (3) (Fig. 2).
4. Lower the brush head body, press the "BRUSH HEAD COMMAND" button (4) on the control panel (Fig. 3).

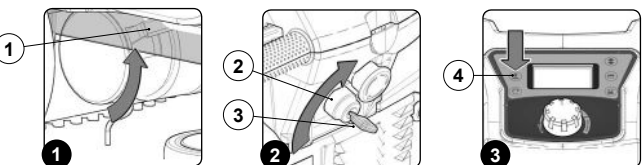

5. As soon as the brush head is in contact with the floor, turn off the appliance, turn the main switch (2) to "0", turning the key (3) a quarter turn to the left (Fig. 4). Remove the key from the instrument panel.
6. Position yourself at the front of the appliance.
7. Remove the splash guard carters (5), remove them (Fig. 5) and lay them gently on the ground.
8. Position yourself at the rear of the appliance.
9. Insert the key (3) into the main switch (2).
10. Start the appliance, turn the main switch (2) to "I", making a quarter turn to the right with the key (3) (Fig. 2).
11. Lift the brush head body, press the "BRUSH HEAD COMMAND" button (4) on the control panel (Fig. 3).
12. Turn off the appliance, turning the main machine switch (2) to "0", turning the key (3) a quarter turn to the left (Fig. 4). Remove the key from the instrument panel.
13. Take all necessary steps to ensure that the device is in a safe condition (see "MACHINE SAFETY").

**⚠️ CAUTION:** these operations must be carried out using protective gloves to avoid any possible contact with the edges or tips of metal objects.

- Position yourself at the front of the appliance.
- Press the brush-holder plate latch (6) and simultaneously rotate the brush (7) according to the direction indicated in the image (Fig. 6).

**N.B.:** The image Fig. 6 shows the rotation direction of the left brush.

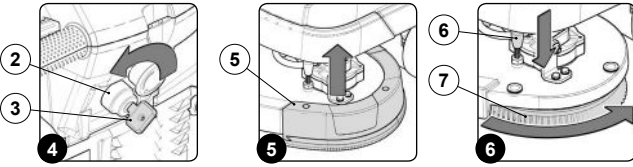

- When brush rotation is prevented, turn until the button on the brush is disengaged from the coupling spring on the brush-holder plate.
- Repeat the same operation for the right-hand brush.
- Clean the brush under running water to remove any impurities from its bristles. Check that the bristles are not worn; in the event of excessive wear, replace the brush (the bristles should be at least 10 mm long). Read the paragraph "ASSEMBLING THE BRUSH (double brush versions with PM system)" for replacing the brush.

**CAUTION:** these operations must be carried out using protective gloves to avoid any possible contact with the edges or tips of metal objects.

**N.B.:** the place designated for this operation must comply with current environmental protection regulations.

### CLEANING THE BRUSH (50BTS double brush versions)

Careful cleaning of the brush guarantees better cleaning of the floor as well as a longer brush head gearmotor lifespan. To clean the brush, proceed as follows:

- Take the device to the dedicated maintenance area.
- Take all necessary steps to ensure that the device is in a safe condition (see "MACHINE SAFETY").

**CAUTION:** these operations must be carried out using protective gloves to avoid any possible contact with the edges or tips of metal objects.

- Position yourself on the right-hand side of the appliance.
- Loosen the retainer knob (1) (Fig. 1).
- Remove the right side splash guard support (2), making sure to shift the blade before removing the splash guard support itself (Fig. 2).
- Remove the rear brush guide hub (3) (Fig. 3).

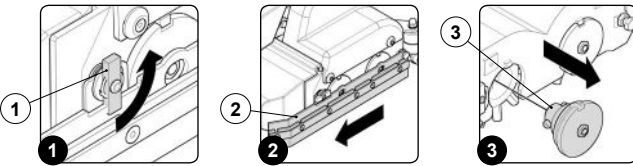

- Extract the brush from the machine.
- Clean the brush under a stream of running water to remove any impurities from its bristles. Check that the bristles are not worn; in the event of excessive wear, replace the brush (the bristles should be at least 10 mm long).
- Repeat the operations described above for the front brush as well.

**N.B.:** If the height of the bristles is less than 10mm, replace the brush. To insert the brush inside the brush head body, read the paragraph "INSTALLING THE BRUSH (50BTS double brush versions)".

- Repeat the operations in reverse order to reassemble all the parts.

### CLEANING THE BRUSH (65BTS double brush versions)

Careful cleaning of the brush guarantees better cleaning of the floor as well as a longer brush head gearmotor lifespan. To clean the brush, proceed as follows:

- Take the device to the dedicated maintenance area.
- Take all necessary steps to ensure that the device is in a safe condition (see "MACHINE SAFETY").

**CAUTION:** these operations must be carried out using protective gloves to avoid any possible contact with the edges or tips of metal objects.

- Stand on the left side of the appliance.
- Remove the left side splash guard support (1) (Fig. 1).
- Remove the brush hub support carter (2) from the brush head body (Fig. 2), remember to move the retainer blade (3) downwards before removing the brush hub support (Fig. 3).

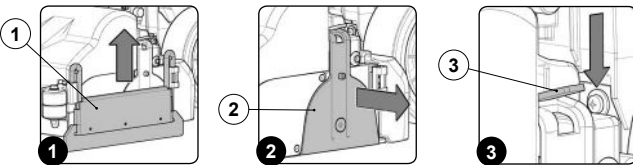

- Remove the rear brush from inside the tunnel (Fig. 4).

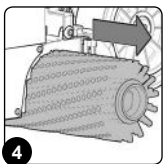

- Clean the brush under a stream of running water to remove any impurities from its bristles. Check that the bristles are not worn; in the event of excessive wear, replace the brush (the bristles should be at least 10 mm long).
- Repeat the operations described above for the front brush as well.

**N.B.:** If the height of the bristles is less than 10mm, replace the brush. To insert the brush inside the brush head body, read the paragraph "INSTALLING THE BRUSH (65BTS double brush versions)".

- Repeat the operations in reverse order to reassemble all the parts.

To clean the brushes with the spray gun, for versions with the SST system, proceed as follows:

- Take the device to the dedicated maintenance area.
- Lift the brush head body and press the "BRUSH HEAD CONTROL" button (1) on the control panel (Fig. 1).
- Raise the squeegee unit and turn the squeegee control lever (2) in the direction of the arrow in (Fig. 2). The lever is located on the back of the device.

**CAUTION:** these operations must be carried out using protective gloves to avoid any possible contact with the edges or tips of metal objects.

- Remove the left side splash guard support (3) (Fig. 3).

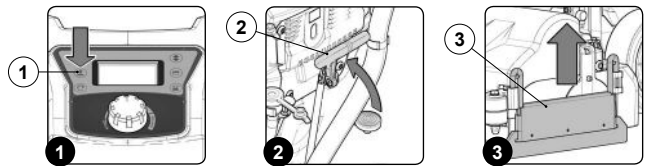

- Remove the brush hub support carter (4) from the brush head body (Fig. 4), remember to move the retainer blade (5) downwards before removing the brush hub support (Fig. 5).
- Remove the rear brush from inside the tunnel (Fig. 6).

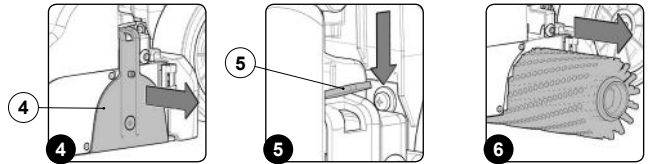

- Remove the spray gun kit from the storage compartment (Fig. 7).
- Connect the male quick-coupler (6) on the spiral hose (7) to the female quick-coupler (8) on the front of the appliance (Fig. 8).
- Connect the male quick-coupler (9) on spray gun (10) to the female quick-coupler (11) on the spiral hose (7) (Fig. 9).

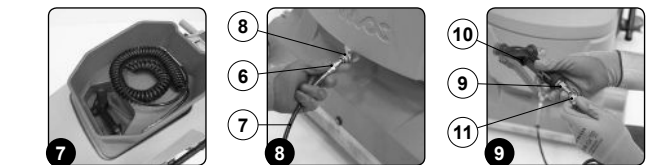

- Activate the spray gun kit by pressing the button (12) on the steering column (Fig. 10).

**CAUTION:** when using the optional tank cleaning kit, you are advised to always wear goggles to avoid any risk of serious injury to your eyes.

**N.B.:** before activating the optional tank cleaning kit, check the level indicator (13) to see how much solution there is in the solution tank (Fig. 11).

- Start the delivery of detergent solution by pressing the lever (14) on the spray gun (Fig. 12).

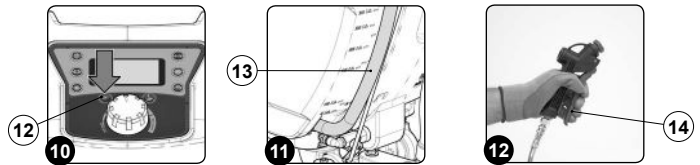

**N.B.:** To adjust the solution jet coming out of the spray gun turn the knob (15) on the accessory itself (Fig. 13).



- Clean the brush under a stream of running water to remove any impurities from its bristles. Check that the bristles are not worn; in the event of excessive wear, replace the brush (the bristles should be at least 10 mm long).



**Recycling symbol:** *N.B.: the place designated for this operation must comply with current environmental protection regulations.*

13. Repeat the operations described above for the front brush as well.

**Warning symbol:** *N.B.: If the height of the bristles is less than 10mm, replace the brush. To insert the brush inside the brush head body, read the paragraph "INSTALLING THE BRUSH (65BTS double brush versions)".*

14. Repeat the operations in reverse order to reassemble all the parts.

### CLEANING THE DEBRIS HOPPER (50BTS double brush versions)

The thorough cleaning of the debris hopper ensures better floor cleaning performance. To clean the debris hopper, proceed as follows:

1. Take the device to the dedicated maintenance area.

**Recycling symbol:** *N.B.: the place designated for this operation must comply with current environmental protection regulations.*

2. Take all necessary steps to ensure that the device is in a safe condition (see "MACHINE SAFETY").

**Hand icon:** *N.B.: these operations must be carried out using protective gloves to avoid any possible contact with the edges or tips of metal objects.*

3. Position yourself on the right-hand side of the appliance.

4. Loosen the retainer knob (1) (Fig. 1).

5. Remove the right side splash guard support (2), making sure to shift the blade before removing the splash guard support itself (Fig. 2).

6. Extract the debris hopper (3) from the brush head unit (Fig. 3).

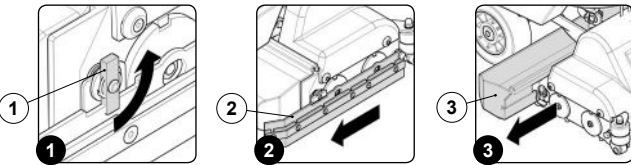

7. Clean the inside of the debris hopper with a stream of running water, using a brush to remove any dirt residues if necessary.

8. Repeat the operations in reverse order to reassemble all the parts.

### CLEANING THE DEBRIS HOPPER (65BTS double brush versions)

The thorough cleaning of the debris hopper ensures better floor cleaning performance. To clean the debris hopper, proceed as follows:

1. Take the device to the dedicated maintenance area.

2. Take all necessary steps to ensure that the device is in a safe condition (see "MACHINE SAFETY").

**Hand icon:** *N.B.: these operations must be carried out using protective gloves to avoid any possible contact with the edges or tips of metal objects.*

3. Stand on the left side of the appliance.

4. Remove the left side splash guard support (1) (Fig. 1).

5. Extract the debris hopper (2) from the brush head body (Fig. 2).

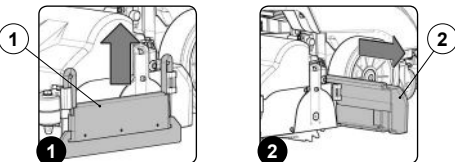

**Information symbol:** *N.B.: To do this, use the moulded handle on the lower part of the debris hopper.*

6. Clean the inside of the debris hopper with a stream of running water, using a brush to remove any dirt residues if necessary.

**Recycling symbol:** *N.B.: the place designated for this operation must comply with current environmental protection regulations.*

7. Repeat the operations in reverse order to reassemble all the parts.

To clean the debris hopper with the spray gun, for versions with the SST system, proceed as follows:

1. Take the device to the dedicated maintenance area.

2. Lift the brush head body and press the "BRUSH HEAD CONTROL" button (1) on the control panel (Fig. 1).

3. Raise the squeegee unit and turn the squeegee control lever (2) in the direction of the arrow in (Fig. 2). The lever is located on the back of the device.

**Hand icon:** *CAUTION: these operations must be carried out using protective gloves to avoid any possible contact with the edges or tips of metal objects.*

4. Remove the left side splash guard support (3) (Fig. 3).

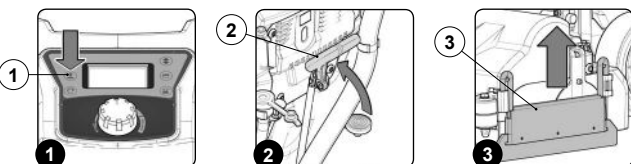

5. Extract the debris hopper (4) from the brush head unit (Fig. 4).

**Information symbol:** *N.B.: To do this, use the moulded handle on the lower part of the debris hopper.*

6. Remove the spray gun kit from the storage compartment (Fig. 5).

7. Connect the male quick-coupler (5) on the spiral hose (6) to the female quick-coupler (7) on the front of the appliance (Fig. 6).

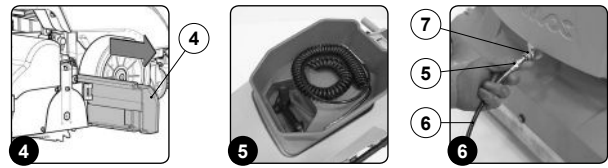

8. Connect the male quick-coupler (8) on the spray gun (9) to the female quick-coupler (10) on spiral hose (6) (Fig. 7).

9. Activate the spray gun kit by pressing the button (11) on the steering column (Fig. 8).

**Eye icon:** *CAUTION: when using the optional tank cleaning kit, you are advised to always wear goggles to avoid any risk of serious injury to your eyes.*

**Information symbol:** *N.B.: Before activating the optional tank cleaning kit, check the level indicator (12) to see how much solution there is in the solution tank (Fig. 9).*

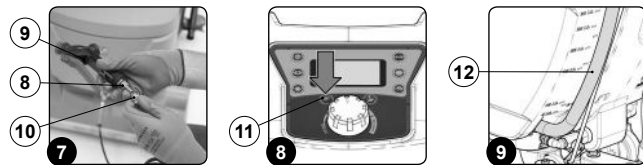

10. Start the delivery of detergent jet by pressing the lever (13) on the spray gun (Fig. 10).

**Information symbol:** *N.B.: To adjust the solution jet coming out of the spray gun turn the knob (14) on the accessory itself (Fig. 11).*

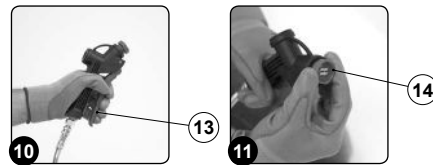

11. Clean the inside of the debris hopper under a jet of detergent solution, using a spatula to remove any dirt residues if necessary.

**Recycling symbol:** *N.B.: the place designated for this operation must comply with current environmental protection regulations.*

12. Repeat the operations in reverse order to reassemble all the parts.

### CLEANING THE VACUUM TUBE

Careful cleaning of the vacuum hose guarantees better cleaning of the floor as well as a longer vacuum motor life. Proceed as follows to clean the vacuum hose:

1. Take the device to the dedicated maintenance area.

2. Take all necessary steps to ensure that the device is in a safe condition (see "MACHINE SAFETY").

**Warning symbol:** *CAUTION: users are advised to always wear protective gloves, to avoid the risk of serious injury to hands.*

3. Remove the vacuum hose (1) from the vacuum nozzle (2) on the squeegee unit (Fig. 1).

4. Remove the vacuum hose (1) via the hole on the back of the recovery tank (Fig. 2).

5. Remove the recovery tank drainage hose from the clamps.

6. Rinse the inside of the vacuum hose with a jet of running water.

7. Repeat the operations in reverse order to reassemble all the parts.

**Warning symbol:** *N.B.: Pay particular attention when placing the vacuum hose behind the lifting chain, as indicated on the label (Fig. 3).*

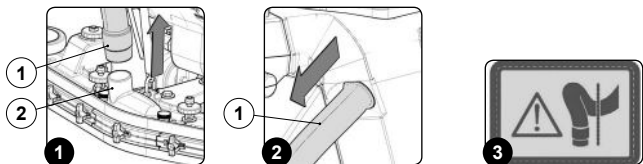

To clean the vacuum hose with the spray gun, for versions with the SST system, proceed as follows:

1. Take the device to the dedicated maintenance area.

2. Lift the brush head body and press the "BRUSH HEAD CONTROL" button (1) on the control panel (Fig. 1).

3. Raise the squeegee unit and turn the squeegee control lever (2) in the direction of the arrow in (Fig. 2). The lever is located on the back of the device.

**CAUTION:** these operations must be carried out using protective gloves to avoid any possible contact with the edges or tips of metal objects.

4. Remove the vacuum hose (3) from the vacuum nozzle (4) on the squeegee body (Fig. 3).

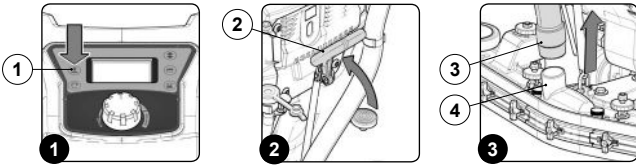

5. Remove the vacuum tube (3) from the hole on the back of the recovery tank (Fig. 4).

6. Remove the recovery tank drainage hose from the clamps.

7. Remove the spray gun kit from the storage compartment (Fig. 5).

8. Connect the male quick-coupler (5) on the spiral hose (6) to the female quick-coupler (7) on the front of the appliance (Fig. 6).



9. Connect the male quick-coupler (8) on the spray gun (9) to the female quick-coupler (10) on spiral hose (6) (Fig. 7).

10. Activate the spray gun kit by pressing the button (11) on the steering column (Fig. 8).

**CAUTION:** when using the optional tank cleaning kit, you are advised to always wear goggles to avoid any risk of serious injury to your eyes.

**N.B.:** Before activating the optional tank cleaning kit, check the level indicator (12) to see how much solution there is in the solution tank (Fig. 9).

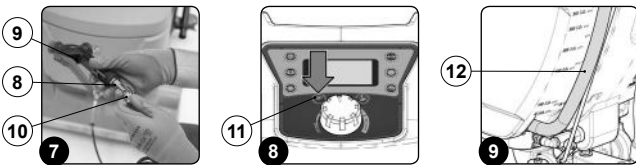

11. Start the delivery of detergent jet by pressing the lever (13) on the spray gun (Fig. 10).

**N.B.:** To adjust the solution jet coming out of the spray gun turn the knob (14) on the accessory itself (Fig. 11).

12. Clean the inside of the vacuum hose with a jet of solution.

13. Repeat the operations in reverse order to reassemble all the parts.

**N.B.:** the place designated for this operation must comply with current environmental protection regulations.

**N.B.:** Pay particular attention when placing the vacuum hose behind the lifting chain, as indicated on the label (Fig. 12).



### EMPTYING THE SOLUTION TANK

Proceed as follows to empty the solution tank:

1. Take the device to the dedicated maintenance area.

2. Take all necessary steps to ensure that the device is in a safe condition (see "MACHINE SAFETY").

**N.B.:** The tanks should be emptied in the place used for draining dirty water.

**N.B.:** the place designated for this operation must comply with current environmental protection regulations.

**CAUTION:** users are advised to always wear protective gloves, to avoid the risk of serious injury to hands.

3. Unscrew the detergent solution cap-filter (1), turning it counter-clockwise (Fig. 1).

4. Repeat the operations in reverse order to reassemble all the parts.

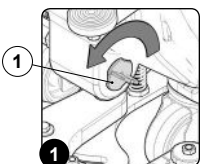

### CLEANING THE WATER SYSTEM FILTER

A thorough cleaning of the solution tank filter guarantees a longer life span of the appliance's water circuit system, ensuring a better floor cleaning performance. Proceed as follows to clean the solution tank's cap-filter:

1. Take the device to the dedicated maintenance area.

2. Take all necessary steps to ensure that the device is in a safe condition (see "MACHINE SAFETY").

3. Make sure the solution tank is empty. If it isn't, empty it (see paragraph "EMPTYING THE SOLUTION TANK").

**N.B.:** The tanks should be emptied in the place used for draining dirty water.

**N.B.:** the place designated for this operation must comply with current environmental protection regulations.

**CAUTION:** users are advised to always wear protective gloves, to avoid the risk of serious injury to hands.

4. Unscrew the detergent solution cap-filter (1), turning it counter-clockwise (Fig. 1).

5. Clean it under a jet of clean water. Remove any impurities that may be present.

6. Repeat the operations in reverse order to reassemble all the parts.

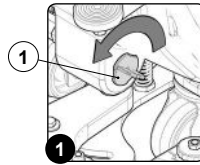

### CLEANING THE WATER SYSTEM (B versions)

Prior to any extended periods of disuse, do the following:

1. Take the device to the dedicated maintenance area.

2. Take all necessary steps to ensure that the device is in a safe condition (see "MACHINE SAFETY").

**N.B.:** users are advised to always wear protective gloves, to avoid the risk of serious injury to hands.

**N.B.:** the place designated for this operation must comply with current environmental protection regulations.

3. Make sure the recovery tank is empty, otherwise empty it completely (read the paragraph "EMPTYING THE RECOVERY TANK").

4. Verify that the quantity of detergent solution in the solution tank is suitable for the type of work you wish to carry out, otherwise fill the solution tank (see the paragraph "FILLING THE SOLUTION TANK WITH WATER"). View the level tube (1) in the rear of the machine (Fig. 1).

5. Grip the handle (1) on the left side of the recovery tank (Fig. 2) and turn the tank as far as it will go, until it reaches the maintenance position (Fig. 3).

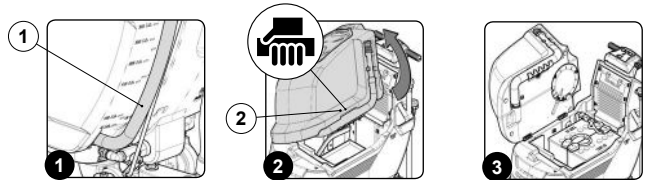

6. Connect the battery connector (3) to the main system connector (2) (Fig. 4).

**ATTENTION:** This process must be carried out by qualified personnel.

7. Grip the handle (2) on the side of the recovery tank (Fig. 5).

8. Turn the recovery tank as far as it will go, to the work position (Fig. 6).

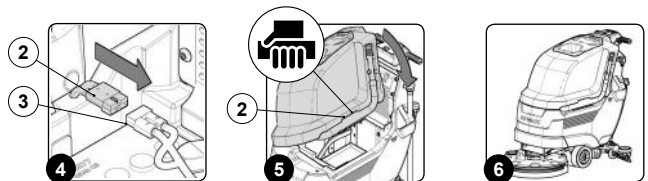

9. Make sure the water tap is fully open; the water adjustment knob (4) should be completely down (Fig. 7).

10. Press the main system control button (5) so it is in the "work" position (Fig. 8).

**N.B.:** when the main system control button is functioning, the LED inside it is activated.

11. Lower the brush head unit by pressing the brush head control pedal (6) on the back of the appliance (Fig. 9).

**N.B.:** Do not bring the brush completely into contact with the floor.

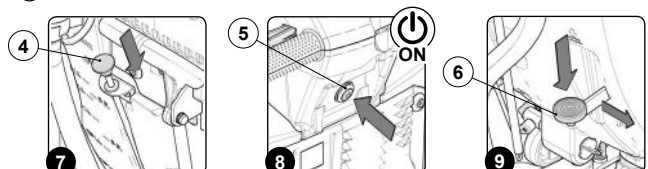

12. Activate the brush head gearmotor using the brush control switch (7) (Fig. 10).
13. When the dead man's lever (8) is engaged, the machine will start to move (Fig. 11).
14. Activate the supply of detergent solution by pressing the switch (9) on the control panel (Fig. 12).



15. Wait a few minutes, normally 2 – 4 minutes, to allow the dosing system to be washed.

**i** **N.B.:** the machine will dispense solution during this operation.

16. After these 2 - 4 minutes have passed, empty the solution tank completely (read the paragraph titled "EMPTYING THE SOLUTION TANK").

#### CLEANING THE WATER SYSTEM (versions BT - BTS - BTO)

Prior to any extended periods of disuse, do the following:

1. Take the device to the dedicated maintenance area.
2. Take all necessary steps to ensure that the device is in a safe condition (see "MACHINE SAFETY").

**CAUTION** Users are advised to always wear protective gloves, to avoid the risk of serious injury to hands.

**N.B.:** the place designated for this operation must comply with current environmental protection regulations.

3. Make sure the recovery tank is empty, otherwise empty it completely (read the paragraph "EMPTYING THE RECOVERY TANK").
4. Verify that the quantity of detergent solution in the solution tank is suitable for the type of work you wish to carry out, otherwise fill the solution tank (see the paragraph "FILLING THE SOLUTION TANK WITH WATER"). View the level tube (1) in the rear of the machine (Fig. 1).
5. Grip the handle (1) on the left side of the recovery tank (Fig. 2) and turn the tank as far as it will go, until it reaches the maintenance position (Fig. 3).

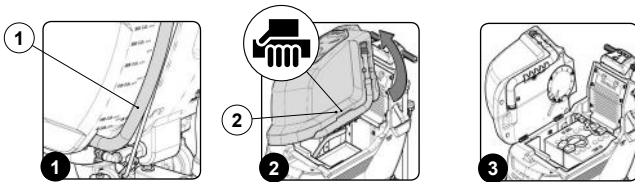

6. Connect the battery connector (3) to the main system connector (2) (Fig. 4).

**ATTENTION:** This process must be carried out by qualified personnel.

7. Grip the handle (2) on the side of the recovery tank (Fig. 5).
8. Turn the recovery tank as far as it will go, to the work position (Fig. 6).

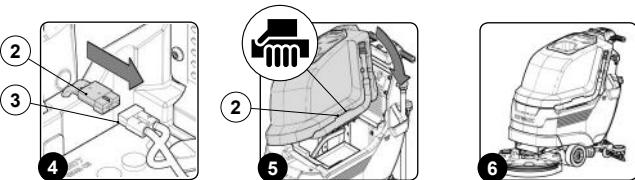

9. Make sure the electronic brake is engaged. If it isn't, turn the lever (4) in the direction indicated by the arrow. The traction gearmotor is located on the left side of the device (Fig. 7).
10. Make sure the water tap is fully open: the water adjustment knob (5) should be completely down (Fig. 8).
11. Turn on the appliance: bring the main switch (6) to its "I" position by turning the key (7) a quarter turn to the right (Fig. 9).

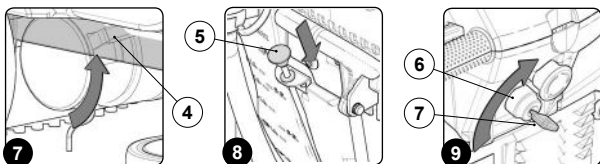

12. When the work screen appears on the control display, press the water flow adjustment button (8) (Fig. 10).

**i** **N.B.:** Set the amount of water present in the dosing system to maximum by pressing the button (8) until the "WATER LEVEL ADJUSTMENT" symbol is completely filled (Fig. 11).

13. Check that the potentiometer knob (9) is set to minimum. If it isn't, turn it completely counter-clockwise (Fig. 12).

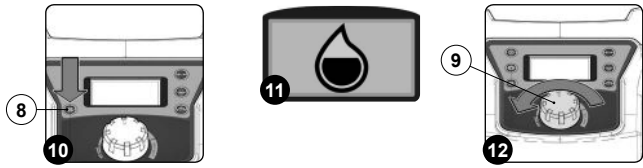

**i** **N.B.:** the device will not start to move (either forward or backward) if the potentiometer adjustment knob (9) is set to minimum.

14. Lower the brush head unit by pressing the brush head control pedal (10) on the back of the appliance (Fig. 13).

15. Lower the squeegee unit using the lever (11) on the back of the appliance (Fig. 14).
16. When the dead man's lever (12) is activated (Fig. 15), the brush head gearmotor and the vacuum motor will enter into function. At the same time, the solenoid valve and dosing system will begin supplying the detergent solution to the brush.

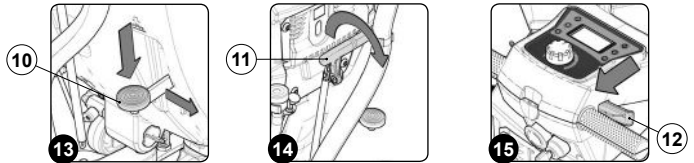

17. Wait a few minutes, normally 2 – 4 minutes, to allow the dosing system to be washed.

**i** **N.B.:** the machine will dispense solution during this operation.

18. After these 2 - 4 minutes have passed, empty the solution tank completely (read the paragraph "EMPTYING THE SOLUTION TANK").

#### CLEANING THE WATER SYSTEM (versions BT - BTS - BTO with PM system)

Prior to any extended periods of disuse, do the following:

1. Take the device to the dedicated maintenance area.
2. Take all necessary steps to ensure that the device is in a safe condition (see "MACHINE SAFETY").

**CAUTION:** users are advised to always wear protective gloves, to avoid the risk of serious injury to hands.

**N.B.:** the place designated for this operation must comply with current environmental protection regulations.

3. Make sure the recovery tank is empty, otherwise empty it completely (read the paragraph "EMPTYING THE RECOVERY TANK").
4. Verify that the quantity of detergent solution in the solution tank is suitable for the type of work you wish to carry out, otherwise fill the solution tank (see the paragraph "FILLING THE SOLUTION TANK WITH WATER"). View the level tube (1) in the rear of the machine (Fig. 1).
5. Grip the handle (1) on the left side of the recovery tank (Fig. 2) and turn the tank as far as it will go, until it reaches the maintenance position (Fig. 3).

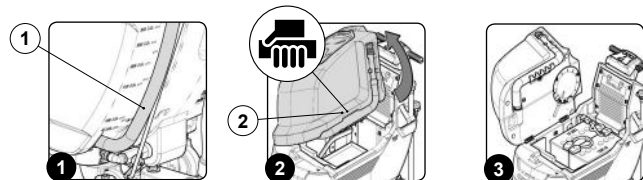

6. Connect the battery connector (3) to the main system connector (2) (Fig. 4).

**ATTENTION:** This process must be carried out by qualified personnel.

7. Grip the handle (2) on the side of the recovery tank (Fig. 5).
8. Turn the recovery tank as far as it will go, to the work position (Fig. 6).

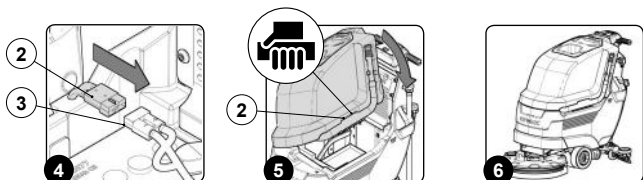

9. Make sure the electronic brake is engaged. If it isn't, turn the lever (4) in the direction indicated by the arrow. The traction gearmotor is located on the left side of the device (Fig. 7).

10. Make sure the water tap is fully open: the water adjustment knob (5) should be completely down (Fig. 8).

11. Turn on the appliance: bring the main switch (6) to its "I" position by turning the key (7) a quarter turn to the right (Fig. 9)).

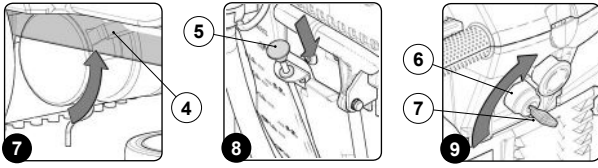

12. When the work screen appears on the control display, press the water flow adjustment button (8) (Fig. 10).

**i** N.B.: Set the amount of water present in the dosing system to maximum by pressing the button (8) until the "WATER LEVEL ADJUSTMENT" symbol is completely filled (Fig. 11).

13. Check that the potentiometer knob (9) is set to minimum. If it isn't, turn it completely counter-clockwise (Fig. 12).



**i** N.B.: the device will not start to move (either forward or backward) if the potentiometer adjustment knob (9) is set to minimum.

14. Lower the brush head body, press the "BRUSH HEAD CONTROL" button (10) on the control panel (Fig. 13).

15. Lower the squeegee unit using the lever (11) on the back of the appliance (Fig. 14).

16. When the dead man's lever (12) is activated (Fig. 15), the brush head gearmotor and the vacuum motor will enter into function. At the same time, the solenoid valve and dosing system will begin supplying the detergent solution to the brush.

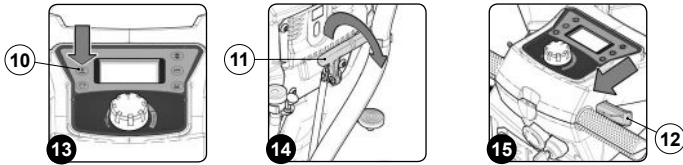

17. Wait a few minutes, normally 2 – 4 minutes, to allow the dosing system to be washed.

**i** N.B.: the machine will dispense solution during this operation.

18. After these 2 - 4 minutes have passed, empty the solution tank completely (read the paragraph "EMPTYING THE SOLUTION TANK").

### CLEANING THE WATER SYSTEM (versions BT - BTS - BTO with CDS system)

Prior to any extended periods of disuse, do the following:

1. Take the device to the dedicated maintenance area.
2. Take all necessary steps to ensure that the device is in a safe condition (see "MACHINE SAFETY").

**CAUTION:** users are advised to always wear protective gloves, to avoid the risk of serious injury to hands.

**N.B.:** the place designated for this operation must comply with current environmental protection regulations.

3. Grip the handle (1) on the left side of the recovery tank (Fig. 1) and turn the tank as far as it will go, until it reaches the maintenance position (Fig. 2).
4. Disconnect the male insert (2) from the female insert (3) present on the cap (4) for the detergent tank (5) (Fig. 3).

**i** N.B.: before pulling on the male insert, push the lever on the female insert.



5. Gripping the handle (6) on the detergent canister (5), remove the canister from the compartment in the solution tank (Fig. 4).

6. Remove the cap (4) from the detergent canister (Fig. 5).

7. Fill the canister with water.

**N.B.:** the place designated for this operation must comply with current environmental protection regulations.

**N.B.:** be sure to respect current environmental protection regulations, and never discharge the detergent directly into the drain.

**i** N.B.: fill with clean water, at a temperature no greater than 50 °C and no less than 10 °C.

8. Make sure you tighten the cap (4) properly to avoid any liquid leaks during the work activities (Fig. 6). Also make sure that the detergent suction filter (7) is correctly positioned on the bottom of the canister (Fig. 7).

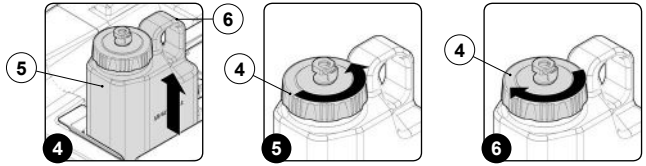

9. Gripping the canister handle (6), place the canister (5) back in its compartment inside the solution tank (Fig. 8).

10. Connect the male insert (2) to the female insert (3) present on the cap (4) for the detergent tank (5) (Fig. 9).

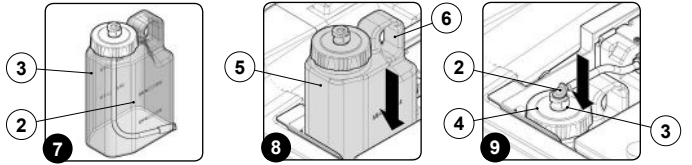

11. Grip the handle (1) on the left side of the recovery tank (Fig. 10) and turn the recovery tank as far as it will go, until it reaches the work position (Fig. 11).

12. Make sure the recovery tank is empty. If this is not the case, empty it (read "EMPTYING THE RECOVERY TANK").

13. Verify that the quantity of detergent solution in the solution tank is suitable for the type of work you wish to carry out, otherwise fill the solution tank (see the paragraph "FILLING THE SOLUTION TANK WITH WATER"). View the level tube (7) at the rear of the machine (Fig. 12).

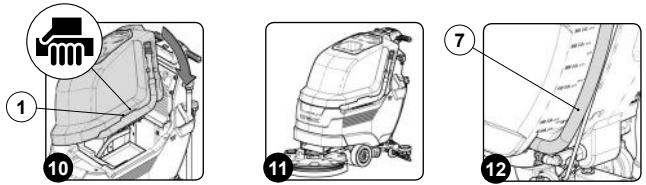

14. Grip the handle (1) on the left side of the recovery tank (Fig. 13) and turn the tank as far as it will go, until it reaches the maintenance position (Fig. 14).

15. Connect the battery connector (9) to the main system connector (8) (Fig. 15).

**ATTENTION:** This process must be carried out by qualified personnel.

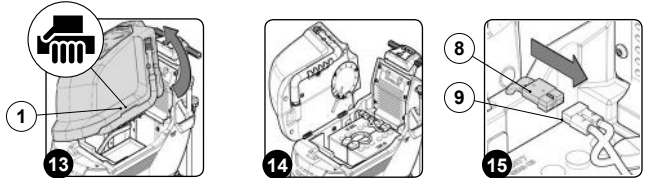

16. Grip the handle (1) on the side of the recovery tank (Fig. 16).

17. Turn the recovery tank as far as it will go, to the work position (Fig. 17).

18. For the BT versions, make sure the electronic brake is engaged. If it isn't, turn the lever (10) in the direction indicated by the arrow. The traction gearmotor is located on the left side of the device (Fig. 18).



19. Make sure the water tap is fully open: the water adjustment knob (11) should be completely down (Fig. 19).

20. For the BT versions, bring the main switch (12) to its "I" position by turning the key (13) a quarter turn to the right (Fig. 20)).

21. When the work screen appears on the control display, press the water flow adjustment button (14) (Fig. 21).

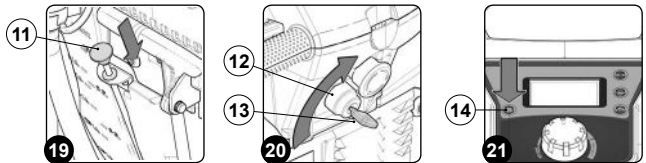

**i** N.B.: Set the amount of water present in the dosing system to maximum by pressing the button (14) until the "WATER LEVEL ADJUSTMENT" symbol is completely filled (Fig. 22).

22. After adjusting the amount of water in the dosing circuit, press the button (15) for adjusting the detergent percentage supplied by the dosing system (Fig. 23).

- i** **N.B.:** Set the percentage of detergent present in the dosing system to the maximum value by pressing the button (15) until the "DETERGENT PERCENTAGE ADJUSTMENT" symbol is completely filled (Fig. 24).

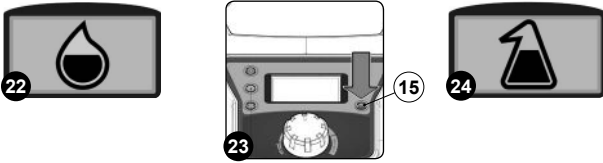

23. Check that the potentiometer knob (16) is set to minimum, otherwise turn it completely counter-clockwise (Fig. 25).

- i** **N.B.:** the device will not start to move (either forward or backward) if the potentiometer adjustment knob (16) is set to minimum.

24. Lower the brush head unit by pressing the brush head control pedal (17) on the back of the appliance (Fig. 26).

25. Lower the squeegee unit using the lever (18) on the back of the appliance (Fig. 27).

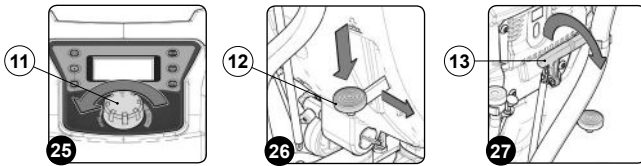

26. When the dead man's lever (19) is activated (Fig. 28), the brush head gearmotor and the vacuum motor will enter into function. At the same time, the solenoid valve and dosing system will begin supplying the detergent solution to the brush.

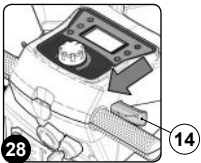

27. Wait a few minutes, normally 2 – 4 minutes, to allow the dosing system to be washed.

- i** **N.B.:** the machine will dispense solution during this operation.

28. Completely empty the solution tank and the detergent canister (read the paragraph "EMPTYING THE SOLUTION TANK" and the paragraph "CLEANING THE DETERGENT CANISTER (VERSIONS WITH CDS)").

### CLEANING THE WATER SYSTEM (versions BT - BTS - BTO with PM and CDS system)

Prior to any extended periods of disuse, do the following:

1. Take the device to the dedicated maintenance area.
2. Take all necessary steps to ensure that the device is in a safe condition (see "MACHINE SAFETY").

**CAUTION:** users are advised to always wear protective gloves, to avoid the risk of serious injury to hands.

**N.B.:** the place designated for this operation must comply with current environmental protection regulations.

3. Grip the handle (1) on the left side of the recovery tank (Fig. 1) and turn the tank as far as it will go, until it reaches the maintenance position (Fig. 2).
4. Disconnect the male insert (2) from the female insert (3) present on the cap (4) for the detergent tank (5) (Fig. 3).

- i** **N.B.:** before pulling on the male insert, push the lever on the female insert.

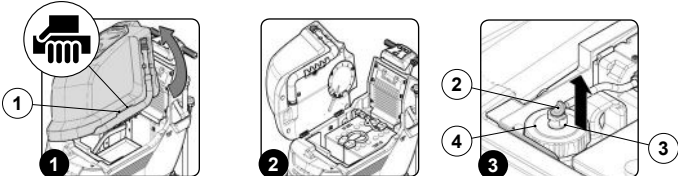

5. Gripping the handle (6) on the detergent canister (5), remove the canister from the compartment in the solution tank (Fig. 4).
6. Remove the cap (4) from the detergent canister (Fig. 5).
7. Fill the canister with water.

**N.B.:** the place designated for this operation must comply with current environmental protection regulations.

**N.B.:** be sure to respect current environmental protection regulations, and never discharge the detergent directly into the drain.

- i** **N.B.:** fill with clean water, at a temperature no greater than 50 °C and no less than 10 °C.

8. Make sure you tighten the cap (4) properly to avoid any liquid leaks during the work activities (Fig. 6). Also make sure that the detergent suction filter (7) is correctly positioned on the bottom of the canister (Fig. 7).

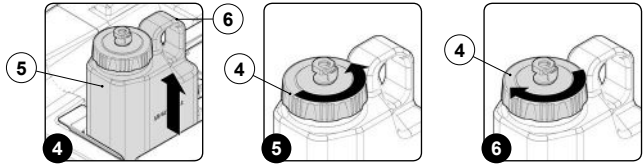

9. Gripping the canister handle (6), place the canister (5) back in its compartment inside the solution tank (Fig. 8).

10. Connect the male insert (2) to the female insert (3) present on the cap (4) for the detergent tank (5) (Fig. 9).

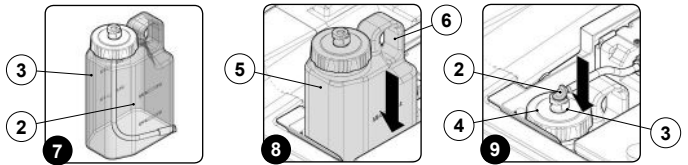

11. Grip the handle (1) on the left side of the recovery tank (Fig. 10) and turn the recovery tank as far as it will go, until it reaches the work position (Fig. 11).

12. Make sure the recovery tank is empty. If this is not the case, empty it (read "EMPTYING THE RECOVERY TANK").

13. Verify that the quantity of detergent solution in the solution tank is suitable for the type of work you wish to carry out, otherwise fill the solution tank (see the paragraph "FILLING THE SOLUTION TANK WITH WATER"). View the level tube (7) at the rear of the machine (Fig. 12).

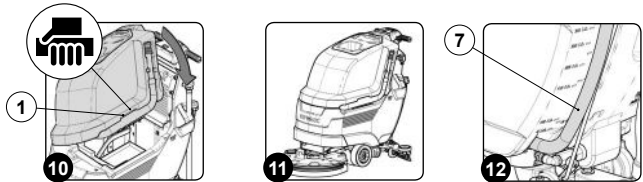

14. Grip the handle (1) on the left side of the recovery tank (Fig. 13) and turn the tank as far as it will go, until it reaches the maintenance position (Fig. 14).

15. Connect the battery connector (9) to the main system connector (8) (Fig. 15).

**⚠ ATTENTION:** This process must be carried out by qualified personnel.

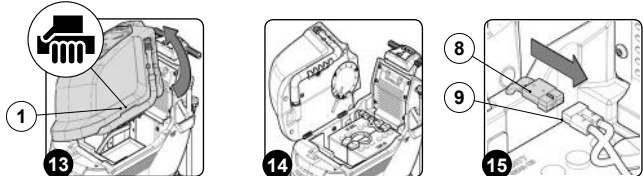

16. Grip the handle (1) on the side of the recovery tank (Fig. 16).

17. Turn the recovery tank as far as it will go, to the work position (Fig. 17).

18. For the BT versions, make sure the electronic brake is engaged. If it isn't, turn the lever (10) in the direction indicated by the arrow. The traction gearmotor is located on the left side of the device (Fig. 18).



19. Make sure the water tap is fully open: the water adjustment knob (11) should be completely down (Fig. 19).

20. For the BT versions, bring the main switch (12) to its "I" position by turning the key (13) a quarter turn to the right (Fig. 20).

21. When the work screen appears on the control display, press the water flow adjustment button (14) (Fig. 21).

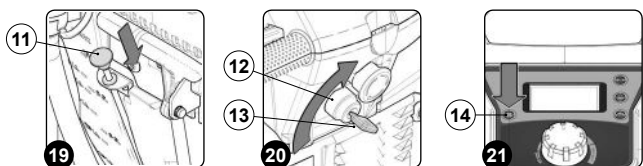

- i** **N.B.:** Set the amount of water present in the dosing system to maximum by pressing the button (14) until the "WATER LEVEL ADJUSTMENT" symbol is completely filled (Fig. 22).

22. After adjusting the amount of water in the dosing circuit, press the button (15) for adjusting the detergent percentage supplied by the dosing system (Fig. 23).

**i** **N.B.:** Set the percentage of detergent present in the dosing system to the maximum value by pressing the button (15) until the "DETERGENT PERCENTAGE ADJUSTMENT" symbol is completely filled (Fig. 24).

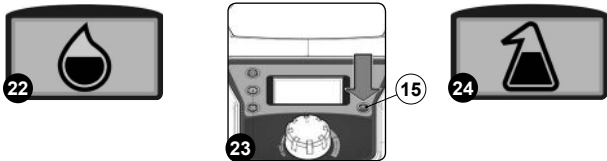

23. Check that the potentiometer knob (16) is set to minimum, otherwise turn it completely counter-clockwise (Fig. 25).

**i** **N.B.:** the device will not start to move (either forward or backward) if the potentiometer adjustment knob (16) is set to minimum.

24. Lower the brush head body, press the "BRUSH HEAD CONTROL" button (12) on the control panel (Fig. 26).

25. Lower the squeegee unit using the lever (18) on the back of the appliance (Fig. 27).

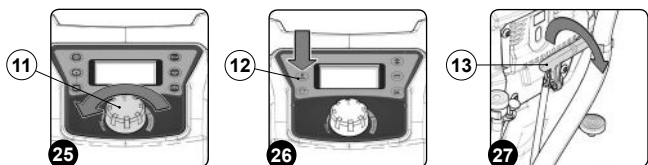

26. When the dead man's lever (19) is activated (Fig. 28), the brush head gearmotor and the vacuum motor will enter into function. At the same time, the solenoid valve and dosing system will begin supplying the detergent solution to the brush.

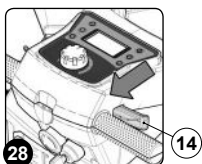

27. Wait a few minutes, normally 2 – 4 minutes, to allow the dosing system to be washed.

**i** **N.B.:** the machine will dispense solution during this operation.

28. Completely empty the solution tank and the detergent canister (read the paragraph "EMPTYING THE SOLUTION TANK" and the paragraph "CLEANING THE DETERGENT CANISTER (VERSIONS WITH CDS)").

### CLEANING THE RECOVERY TANK

To clean the recovery tank, proceed as follows:

1. Take the device to the dedicated maintenance area.
2. Take all necessary steps to ensure that the device is in a safe condition (see "MACHINE SAFETY").

**CAUTION:** users are advised to always wear protective gloves, to avoid the risk of serious injury to hands.

3. Remove the drainage hose of the recovery tank from the clamps; it is located at the rear of the machine (Fig. 1).
4. Bend the end of the drainage tube, so as to create a choke and prevent the content from coming out (Fig. 2), put the tube on the discharge surface and gradually release the tube.

**N.B.:** the place designated for this operation must comply with current environmental protection regulations.

5. Grip the handle (1) on the back of the recovery tank cover and remove it (Fig. 3).



6. With the recovery tank empty, rotate the recovery tank cover support (2). The optional support is positioned on the left side of the appliance (Fig. 4).
7. Insert the clamp (3) of the recovery tank cover in the slot (4) on the recovery tank cover support (Fig. 5).

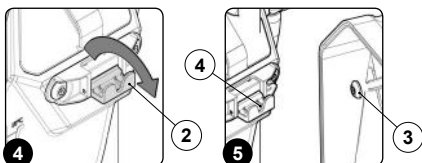

8. Rinse the inside with a jet of water, if necessary use a spatula to remove the sludge that has accumulated at the bottom of the tank.
9. Repeat the operations in reverse order to reassemble all the parts.

To clean the recovery tank filter-float with the spray gun, for versions with the SST system, proceed as follows:

1. Take the device to the dedicated maintenance area.
2. Lift the brush head body and press the "BRUSH HEAD CONTROL" button (1) on the control panel (Fig. 1).
3. Raise the squeegee unit and turn the squeegee control lever (2) in the direction of the arrow in (Fig. 2). The lever is located on the back of the device.
4. Remove the drainage hose of the recovery tank (3) from the clamps; it is located at the rear of the machine (Fig. 3).

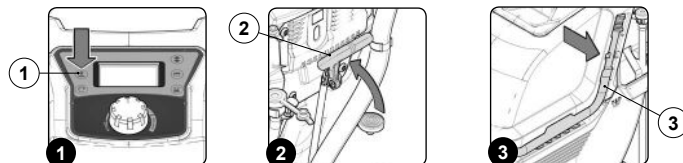

5. Bend the end of the drainage tube, so as to create a choke and prevent the content from coming out (Fig. 4), put the tube on the discharge surface and gradually release the tube.

**N.B.:** the place designated for this operation must comply with current environmental protection regulations.

6. Grip the handle (4) on the back of the recovery tank cover and remove it (Fig. 5).
7. Rotate the recovery tank cover support (5). The optional support is positioned on the left side of the appliance (Fig. 6).

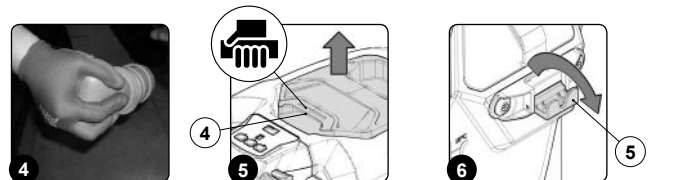

8. Insert the clamp (6) of the recovery tank cover in the slot (7) in the recovery tank cover support (Fig. 7).
9. Remove the spray gun kit from the storage compartment (Fig. 8).
10. Connect the male quick-coupler (8) on the spiral hose (9) to the female quick-coupler (10) on the front of the appliance (Fig. 9).



11. Connect the male quick-coupler (11) on spray gun (12) to the female quick-coupler (13) on the spiral hose (9) (Fig. 10).
12. Activate the spray gun kit by pressing the button (14) on the steering column (Fig. 11).

**CAUTION:** when using the optional tank cleaning kit, you are advised to always wear goggles to avoid any risk of serious injury to your eyes.

**i** **N.B.:** Before activating the optional tank cleaning kit, check the level indicator (15) to see how much solution there is in the solution tank (Fig. 12).

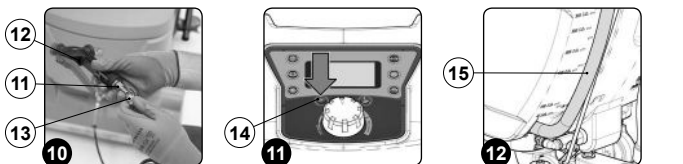

13. Start the delivery of detergent jet by pressing the lever (16) on the spray gun (Fig. 13).

**i** **N.B.:** To adjust the solution jet coming out of the spray gun turn the knob (17) on the accessory itself (Fig. 14).

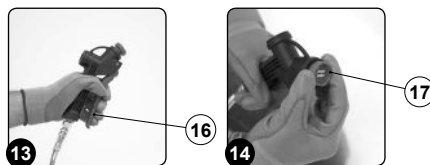

14. Rinse the inside with a jet of water, if necessary use a spatula to remove the sludge that has accumulated at the bottom of the tank.
15. Repeat the operations in reverse order to reassemble all the parts.

### CLEANING THE SOLUTION TANK

Proceed as follows to clean the solution tank:

1. Take the device to the dedicated maintenance area.
2. Take all necessary steps to ensure that the device is in a safe condition (see "MACHINE SAFETY").

**CAUTION:** users are advised to always wear protective gloves, to avoid the risk of serious injury to hands.

3. Close the flow from the tap on the back of the appliance by pulling the tap command knob (1) on the back of the appliance upwards (Fig. 1).
4. Remove the solution tank level tube from its seat (2), empty the solution tank (Fig. 2).

**N.B.:** the place designated for this operation must comply with current environmental protection regulations.

**N.B.:** Before removing the solution tank level tube from its seat (2), close the drainage cap on the tube itself.

5. To facilitate the outflow of water from the solution tank, remove the solution tank water inlet cap (3) on the left side of the appliance (Fig. 3).

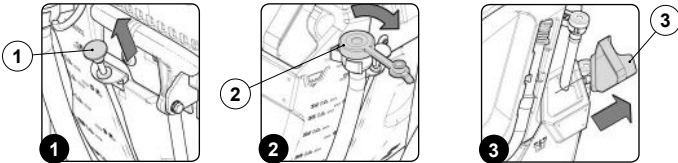

6. Remove the solution tank drainage cap (4) from its seat, unscrewing it in the direction of the arrow (Fig. 4).

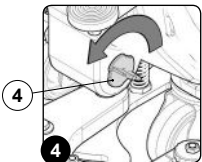

7. Repeat the operations in reverse order to reassemble all the parts.

### CLEANING THE DETERGENT CANISTER (versions with CDS system)

After filling the solution tank with clean water, you must fill the detergent canister. Before filling the canister, carry out the following steps:

1. Take the device to the dedicated maintenance area.
2. Take all necessary steps to ensure that the device is in a safe condition (see "MACHINE SAFETY").

**CAUTION:** users are advised to always wear protective gloves, to avoid the risk of serious injury to hands.

**N.B.:** the place designated for this operation must comply with current environmental protection regulations.

3. Grip the handle (1) on the left side of the recovery tank (Fig. 1) and turn the tank as far as it will go, until it reaches the maintenance position (Fig. 2).
4. Disconnect the male insert (2) from the female insert (3) present on the cap (4) for the detergent tank (5) (Fig. 3).

**N.B.:** before pulling on the male insert, push the lever on the female insert.

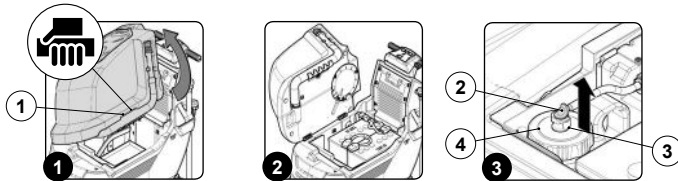

5. Gripping the handle (6) on the detergent canister (5), remove the canister from the compartment in the solution tank (Fig. 4).
6. Remove the cap (4) from the detergent canister (Fig. 5).
7. Remove any detergent residue.

**N.B.:** the place designated for this operation must comply with current environmental protection regulations.

**N.B.:** be sure to respect current environmental protection regulations, and never discharge the detergent directly into the drain.

8. Rinse the inside of the canister with a jet of running water.

9. Make sure you tighten the cap (4) properly to avoid any liquid leaks during the work activities (Fig. 6). Also make sure that the detergent suction filter (7) is correctly positioned on the bottom of the canister (Fig. 7).

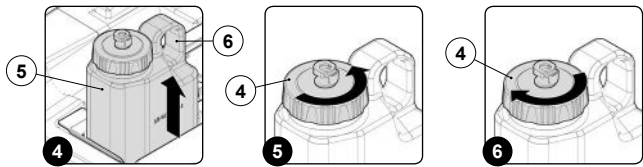

10. Gripping the canister handle (6), place the canister (5) back in its compartment inside the solution tank (Fig. 8).

11. Connect the male insert (2) to the female insert (3) present on the cap (4) for the detergent tank (5) (Fig. 9).

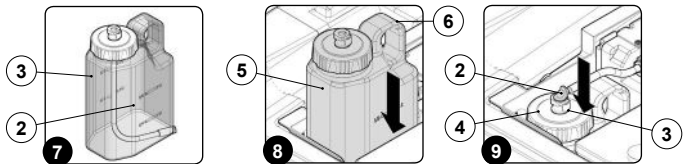

12. Grip the handle (1) on the left side of the recovery tank (Fig. 10) and turn the recovery tank as far as it will go, until it reaches the work position (Fig. 11).

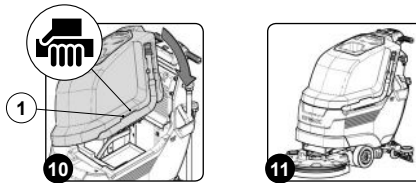

### ADJUSTING

#### ADJUSTING THE SQUEEGEE UNIT

Careful adjustment of the height between the squeegee rubber and the floor guarantees better drying and cleaning of the flooring as well as a longer vacuum motor life. To adjust the squeegee rubber, proceed as follows:

1. Take the device to the dedicated maintenance area.
2. Get in the driving seat, behind the machine.
3. For B versions, switch on the appliance by pressing the main switch (1) on the back of it (Fig. 1).

**N.B.:** in B versions, the main switch (1) is in the work position when the LED inside it is ON and the activation symbol is visible.

4. For BT versions, switch on the machine by bringing the main switch (2) to "I" and making a quarter turn to the right with the key (3) (Fig. 2).
5. Lower the brush head unit by pressing the brush head control pedal (4) on the back of the appliance (Fig. 3).

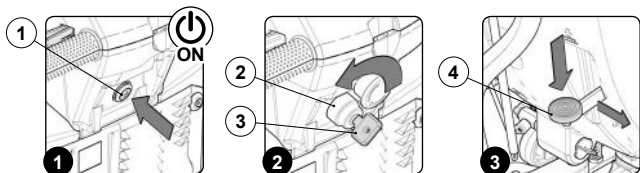

6. Lower the squeegee unit by means of the lever (5) on the back of the appliance (Fig. 4).
7. Adjust the detergent solution flow (read "ADJUSTING THE DETERGENT SOLUTION (VERSIONS WITHOUT CDS)" or "ADJUSTING THE DETERGENT SOLUTION (VERSIONS WITH CDS)").
8. By activating the dead man's lever (6), the machine will start to move (Fig. 5).
9. During the first few metres of work, check that the squeegee rubber blades touch the floor evenly. If the rubber blade's tilt needs to be increased in the middle, tighten the screw (8) (Fig. 6). To decrease its tilt, simply turn the screw (8) in the opposite direction.

**N.B.:** Loosen the locknut (7) before turning the screw (8). When finished, remember to secure the screw by tightening the locknut (7).



10. During working operation, the rear rubber blade should be slightly tilted backwards by about 30° - 45° with respect to the floor along its whole length. If you need to adjust the height of the rubber blades in relation to the floor, turn the knob (9) (the diagram only shows the left knob) counter-clockwise to raise the squeegee or clockwise to lower it (Fig. 7).

**i** **N.B.:** the right and left wheels must be adjusted to the same level, so the squeegee can work parallel to the floor.

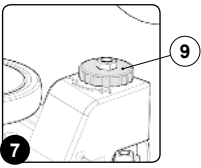

### EXTRAORDINARY MAINTENANCE

#### REPLACING THE SQUEEGEE BODY RUBBER BLADES

Ensuring the good condition of the squeegee body rubber blades guarantees better floor cleaning and drying results, as well as a longer service life for the vacuum motor.  
To replace the squeegee body rubber blades, proceed as follows:

1. Take the device to the dedicated maintenance area.
2. Take all necessary steps to ensure that the device is in a safe condition (see **"MACHINE SAFETY"**).
3. Raise the squeegee unit off the floor and press the squeegee unit control lever (1) on the back of the device (Fig. 1).

**i** **N.B.:** these operations must be carried out using protective gloves to avoid any possible contact with the edges or tips of metal objects.

4. Remove the vacuum hose (2) from the vacuum nozzle (3) on the squeegee unit (Fig. 2).
5. Completely unscrew the knobs (4) in the squeegee unit pre-assembly (Fig. 3).

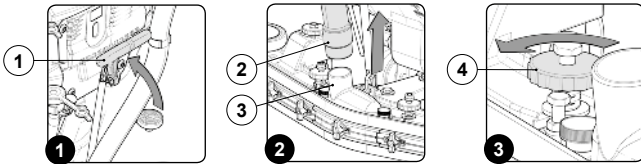

6. Remove the squeegee unit from the slits in the squeegee connector (Fig. 4).
7. Turn the wing nuts (5) to the horizontal position (Fig. 5).
8. Remove the front rubber-pressing blades (6) (Fig. 5).
9. Remove the front rubber blade (7) and replace it (Fig. 5).

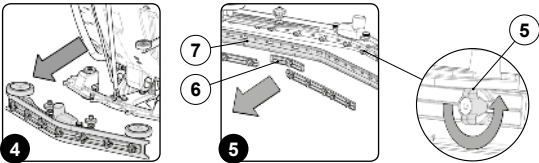

10. Turn the wing nuts (8) to the horizontal position (Fig. 6).
11. Remove the front rubber-pressing blades (9) (Fig. 6).
12. Remove the rear rubber blade (10) and replace it (Fig. 6).

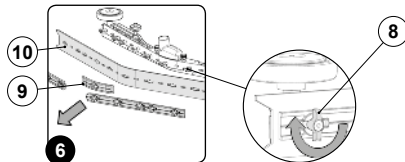

13. Proceed in reverse to replace the rubber.

### DISPOSAL

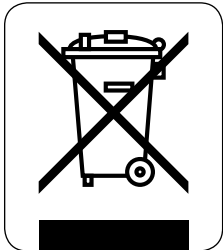

To dispose of the appliance, take it to a demolition centre or an authorised collection centre.

Before scrapping the appliance, it is necessary to remove and separate out the following materials, then send them to the appropriate collection centres in accordance with applicable environmental hygiene regulations:

- Brushes
- Felt
- Electric and electronic parts\*
- Batteries
- Plastic parts (tanks and handlebars)
- Metal parts (levers and frame)

(\*) In particular, contact your distributor when scrapping electric and electronic parts.

### EC DECLARATION OF CONFORMITY



The undersigned manufacturer:  
**COMAC S.p.A.**  
Via Maestri del Lavoro, 13  
37059 Santa Maria di Zevio (VR)  
declares under its sole responsibility that the products

**FLOOR SCRUBBING MACHINES**  
mod. ANTEA 50 B, ANTEA 50 BT, ANTEA 50 BTS, ANTEA 50 BTO  
VERSA 55BT, VERSA 55BT PM, VERSA 65BT, VERSA 65BT PM, VERSA 50BTS

comply with the provisions of Directives:

- 2006/42/EC: Machinery Directive.
- 2014/30/EC: Electromagnetic compatibility directive.

They also comply with the following standards:

- EN 60335-1: Household and similar electrical appliances - Safety. Part 1: Generic standards.
- EN 60335-2-72: Household and similar electrical appliances - safety. Part 2: Specific standards for automatic machines for floor treatment for commercial and industrial use.
- EN 12100-1: Machine safety - Fundamental concepts, fundamental principles for design - Part 1: Basic terminology and methodology.
- EN 12100-2: Machine safety - Fundamental concepts, fundamental principles for design - Part 2: Technical principles.
- EN 61000-6-2: Electromagnetic compatibility (EMC) - Part 6-2: Generic standards - Immunity for industrial environments.
- EN 61000-6-3: Electromagnetic compatibility (EMC) - Part 6-3: Generic standards - Standard emission for residential, commercial and light-industrial environments.
- EN 62233: Household and similar electrical appliances - Electromagnetic fields - Methods for evaluation and measurement.

The person authorized to compile the technical file:

Mr. Giancarlo Ruffo  
Via Maestri del Lavoro, 13  
37059 Santa Maria di Zevio (VR) - ITALY

Santa Maria di Zevio (VR), 28/09/2015

Comac S.p.A.  
Legal representative  
Giancarlo Ruffo

The undersigned manufacturer:  
**COMAC S.p.A.**  
Via Maestri del Lavoro, 13  
37059 Santa Maria di Zevio (VR)  
declares under its sole responsibility that the products

**FLOOR SCRUBBING MACHINES**  
mod. ANTEA 50 B CB, ANTEA 50 BT CB, ANTEA 50 BTS CB, ANTEA 50 BTO CB  
VERSA 55BT CB, VERSA 55BT PM CB, VERSA 65BT CB, VERSA 65BT PM CB, VERSA 50BTS CB

comply with the provisions of Directives:

- 2006/42/EC: Machinery Directive.
- 2014/35/EC: Low Voltage Directive.
- 2014/30/EC: Electromagnetic compatibility directive.

They also comply with the following standards:

- EN 60335-1: Household and similar electrical appliances - Safety. Part 1: Generic standards.
- EN 60335-2-72: Household and similar electrical appliances - safety. Part 2: Specific standards for automatic machines for floor treatment for commercial and industrial use.
- EN 60335-2-29: Household and similar electrical appliances - safety. Part 2: Special standards for battery chargers.
- EN 12100-1: Machine safety - Fundamental concepts, fundamental principles for design - Part 1: Basic terminology and methodology.
- EN 12100-2: Machine safety - Fundamental concepts, fundamental principles for design - Part 2: Technical principles.
- EN 61000-6-2: Electromagnetic compatibility (EMC) - Part 6-2: Generic standards - Immunity for industrial environments.
- EN 61000-6-3: Electromagnetic compatibility (EMC) - Part 6-3: Generic standards - Standard emission for residential, commercial and light-industrial environments.
- EN 61000-3-2: Electromagnetic compatibility (EMC) - Part 3-2: Limits - Limits for emission of harmonic current (Equipment with input current  $\leq 16$  A per phase).
- EN 61000-3-3: Electromagnetic compatibility (EMC) - Part 3-3: Limits - Voltage and flicker variation limit in supply systems at low voltage for equipment with nominal current  $\leq 16$  A.
- EN 55014-1: Electromagnetic compatibility - Regulations for household appliances, electrical devices and similar equipment. Part 1: Emission - Regulation for product family.
- EN 55014-2: Electromagnetic compatibility - Regulations for household appliances, electrical devices and similar equipment. Part 2: Immunity - Regulation for product family.
- EN 62233: Household and similar electrical appliances - Electromagnetic fields - Methods for evaluation and measurement.

The person authorized to compile the technical file:

Mr. Giancarlo Ruffo  
Via Maestri del Lavoro, 13  
37059 Santa Maria di Zevio (VR) - ITALY

Santa Maria di Zevio (VR), 28/09/2015

Comac S.p.A.  
Legal representative  
Giancarlo Ruffo



## TROUBLESHOOTING

This chapter lists the most common problems linked with the use of the appliance. If you are unable to resolve the problems with the information given here, please contact your nearest assistance centre.

PROBLEM	POSSIBLE CAUSE	SOLUTION
THE APPLIANCE DOES NOT SWITCH ON	The main switch is in the rest position (B versions).	Make sure the main switch is in the work position, the LED inside it is ON, and the ON symbol is visible. If this is not the case, press the main switch.
	The main switch is on "0" (BT versions).	Make sure that the main switch is at "I", if not turn the key a quarter turn to right.
	Check that, when switched on, there are no alarm messages on the control display (BT versions).	Stop the machine and contact the technician at the service centre.
	Make sure that the batteries are correctly connected to each other and that the battery connector is connected to the electrical system connector.	Insert the batteries into the machine (see the section " <a href="#">CONNECTING THE BATTERIES TO THE MACHINE'S ELECTRICAL SYSTEM</a> ").
	Check the charge level of the batteries.	If the battery charge level is critical, carry out a complete charging cycle (read " <a href="#">RECHARGING THE BATTERIES</a> " or " <a href="#">RECHARGING THE BATTERIES (versions with CB system)</a> ").
	Check to make sure that the appliance is not still in its battery charging phase (versions with CB system).	Perform the procedure to disconnect the power cable from the battery charger.
THE BATTERIES DO NOT WORK CORRECTLY	The batteries are not connected correctly.	Properly connect the cable bridge, the output voltage should be 24V. Properly connect the battery cable connector to the connector of the general system cable.
	The terminals of the batteries are oxidized.	Unplug all cables from the batteries, clean the battery terminals, apply a little grease and restore the electrical connections (read the battery user manual, the manual provided by the battery manufacturer).
THE BATTERY CHARGER DOES NOT WORK	The plug of the power cable is not correctly inserted in the socket in the battery charger incorporated into the machine (versions with CB system).	Check that the plug in the battery charger power cable is connected to the socket in the battery charger.
	The power supply cable plug is not correctly inserted in the mains socket.	Check that the plug on the battery charger's power cable is connected to the mains socket. Try another socket if necessary.
	The characteristics of the mains power supply do not correspond to those required by the battery charger.	Check that the characteristics in the battery charger plate are the same as those of the mains supply.
	The LEDs of the battery charger flash repeatedly (with CB system).	Referring to the battery charger use and maintenance manual, check the meaning of the flashing signals that the battery charger emits during the battery recharge stage.
	The plug of the power cable is not correctly inserted in the socket in the battery charger incorporated into the machine (versions with CB system).	Check that the plug in the battery charger power cable is connected to the socket in the battery charger.
	The battery charger is not connected to the mains.	Connect the battery charger to a powered electrical outlet.
	The battery charger is not connected to the batteries.	Connect the battery charger to the batteries.
THE DEVICE HAS A VERY LOW OPERATING AUTONOMY	Check the battery charge level (check the symbol on the control display).	If the battery charge level is critical, carry out a complete charging cycle (read " <a href="#">RECHARGING THE BATTERIES</a> " or " <a href="#">RECHARGING THE BATTERIES (versions with CB system)</a> ").
	The batteries do not work correctly.	Read paragraph " <a href="#">THE BATTERIES DO NOT WORK CORRECTLY</a> ".
	The battery charger does not work.	Read paragraph " <a href="#">THE BATTERY CHARGER IS NOT WORKING</a> ".
	The batteries have already undergone many discharging and recharging cycles.	Replace the batteries.
THE APPLIANCE DOES NOT PROCEED STRAIGHT.	The brush is not properly connected.	Connect the brush correctly.
	The brush head is not properly adjusted.	Read paragraph "Brush head adjustment".
THE APPLIANCE DOES NOT MOVE	The dead man's levers are not activated.	Press the dead man's levers under the control handlebar.
	The potentiometer adjusting knob is set to minimum adjustment (BT versions).	Gradually turn the potentiometer adjustment knob clockwise to regulate the speed of the appliance (read the paragraph " <a href="#">ADJUSTING THE FORWARD SPEED (BT - BTS - BTO versions)</a> ").
	The electronic brake of the traction gearmotor is not engaged (BT versions).	Engage the electric brake, turn the lever in the traction motor counter-clockwise (the traction motor is in the rear right of the appliance).
INSUFFICIENT DETERGENT SOLUTION ON THE BRUSHES	The detergent solution tap is partially or completely closed.	Move the tap lever control knob downward.
	The quantity of detergent solution in the water system is not sufficient for the work to be carried out.	Check that the amount of detergent solution in the machine's water system is right for the work to be carried out (read the paragraph " <a href="#">REGULATING THE DETERGENT SOLUTION</a> ").
	Detergent solution filter obstructed.	Check the detergent solution filter isn't obstructed. If it is, clean it (see " <a href="#">CLEANING THE WATER SYSTEM FILTER</a> ").
THE DEVICE DOES NOT CLEAN CORRECTLY	The appliance does not switch on.	Read the section " <a href="#">THE APPLIANCE DOES NOT SWITCH ON</a> ".
	Not enough detergent solution comes out.	Read the section " <a href="#">INSUFFICIENT DETERGENT SOLUTION ON THE BRUSHES</a> ".
	The brush is not correctly inserted in the appliance.	Make sure the brush is correctly inserted in the appliance (read " <a href="#">ASSEMBLING THE BRUSH</a> ").
	The type of brush used is not suitable for the dirt to be cleaned.	Make sure the brushes fitted on the appliance are suitable for the task to be carried out (read " <a href="#">CHOOSING AND USING THE BRUSHES</a> ").
	The brush bristles or the pad are excessively worn.	Check the state of wear of the brush and replace it if necessary (see the paragraph " <a href="#">INSTALLING THE BRUSH</a> ").

PROBLEM	POSSIBLE CAUSE	SOLUTION
THE SQUEEGEE DOES NOT DRY PERFECTLY	The vacuum unit is obstructed.	Make sure the squeegee is free of obstructions (read " <a href="#">CLEANING THE SQUEEGEE BODY</a> ").
		Make sure the vacuum tube is free of obstructions (see " <a href="#">CLEANING THE VACUUM TUBE</a> ").
	The cap on the recovery tank drainage tube is not properly positioned.	Check that the cap on the recovery tank drainage tube is positioned properly.
	The recovery tank cover is not positioned correctly.	Check that the recovery tank cover is properly positioned on the appliance.
EXCESSIVE FOAM PRODUCTION	The detergent being used is not suitable.	Check that a low foam detergent has been used. If necessary, add a small quantity of anti-foam liquid to the recovery tank.
	The floor is not very dirty.	Dilute the detergent more.
THE DEVICE DOES NOT VACUUM CORRECTLY	The recovery tank is full.	Empty the recovery tank (see " <a href="#">EMPTYING THE RECOVERY TANK</a> ").
	The vacuum device is obstructed	Read the section " <a href="#">THE SQUEEGEE DOES NOT DRY PERFECTLY</a> ".

## CHOOSING AND USING BRUSHES

### POLYPROPYLENE BRUSH (PPL)

Used on all types of floors. Good resistance to wear and tear, and hot water (no greater than 50 °C.). The polypropylene is non-hygroscopic and therefore retains its characteristics even when working in wet conditions.

### ABRASIVE BRUSH

The bristles of this type of brush are charged with highly aggressive abrasives. It is used to clean very dirty floors. To avoid floor damage, work only with the pressure strictly necessary.

### THICKNESS OF THE BRISTLES

Thicker bristles are more rigid and are therefore used on smooth floors or floors with small joints.

On uneven floors or those with deep joints, it is advisable to use softer bristles which can enter the gaps more easily.

Remember that when the bristles are worn and therefore too short, they will become rigid and are no longer able to penetrate and clean deep down. In this case, like with over-large bristles, the brush tends to jump.

### PAD HOLDER

The pad holder is recommended for cleaning shiny surfaces.

There are two types of pad holder:

1. The traditional pad holder is fitted with a series of anchor points that allow the abrasive floor pad to be held and dragged while working.
2. the CENTRE LOCK type pad holder not only has anchor points, but also a snap-type central locking system in plastic that allows the abrasive floor pad to be perfectly centred and held without any risk of it becoming detached. This type of pad holder is recommended above all for machines with more than one brush, where the centring of the abrasive discs is difficult.

### RED PAD

Suitable for frequent use on relatively clean floors. Even cleans without water, and polishes by removing marks.

### GREEN PAD

Suitable for removing surface layers of wax and for preparing the flooring for subsequent treatments. For wet use.

### BLACK PAD

Suitable for wet scraping heavy layers of wax. Removes the old finish, and eliminates burrs in concrete.

APPLIANCE	No. OF BRUSHES	CODE	TYPE OF BRISTLES	Ø BRISTLES	Ø BRUSHES	BRUSH LENGTH	NOTES
ANTEA 50B ANTEA 50BT	1	404653	PPL	0.9	508	-	BLACK BRUSH
	1	404654	PPL	0.3	508	-	BLUE BRUSH
	1	405631	PPL	0.6	508	-	WHITE BRUSH
	1	405632	ABRASIVE		508	-	BRUSH
	1	405527			497	-	PAD HOLDER
ANTEA 50BTS VERSA 50BTS	1	405639	PPL	0.5	110	500	FRONT BRUSH (WHITE)
	1	405641	ABRASIVE		110	500	FRONT BRUSH
	1	405640	PPL	0.3	110	500	REAR BRUSH (LIGHT BLUE)
ANTEA 50BTO	1	442005					RED PAD 508X355
	1	442661					GREEN PAD 508X355
	1	442662					BLACK PAD 508X355
VERSA 55BT	2	427709	PPL	0,3	280		BLUE BRUSH
	2	427710	PPL	0.6	280		WHITE BRUSH
	2	427711	PPL	0.9	280		BLACK BRUSH
	2	427712	ABRASIVE		280		ABRASIVE BRUSH
	2	427713			280		PAD HOLDER WITH CENTER LOCK
VERSA 65BT	2	422189	PPL	0,3	340		BLUE BRUSH
	2	422971	PPL	0.6	340		WHITE BRUSH
	2	422972	PPL	0.9	340		BLACK BRUSH
	2	422981	ABRASIVE		340		ABRASIVE BRUSH
	2	422973			330		PAD HOLDER WITH CENTER LOCK
VERSA 65BTS	2	445729	PPL	0.6	130	610	WHITE BRUSH
	2	448042	PPL	0.3	130	610	BLUE BRUSH
	2	448043	ABRASIVE		130	610	BRUSH





COMAC S.p.A. - Via Maestri del Lavoro, 13 - 37059 S. Maria di Zevio - Verona - Italy  
Tel. +39 045 8774222 – Fax +39 045 8750303 – E-mail: [com@comac.it](mailto:com@comac.it)  
[www.comac.it](http://www.comac.it)